

JUSTICE

F U R N I T U R E

NORIX[®]
J U S T I C E

JUSTICE

F U R N I T U R E



Norix® offers a complete range of prison furniture for every corrections application, including cell furniture, dayroom furniture and other detention furniture for use throughout your facility.

Norix® jail products meet or exceed testing requirements for corrections furniture and are designed especially for challenging environments that need institutional-grade products that stand up to the strain of continuous use.

TABLE OF CONTENTS

3 Seating

15 Outdoor Furniture

18 Tables

25 Kids

27 Mattresses / Sleeping Quarters

34 High Security Mirrors / Visitation

36 Detention Furniture / Accessories

ENGINEERED
TO ENDURE®



VESTA™ SERIES



The Vesta™ seating line excels in justice environments due to its robust and minimalist design. The sweeping form fully contacts the floor removing contraband concealment areas and ligature points. Modern style, combined with carefully studied color options, can help humanize spaces for the mental well-being of staff, visitors, and inmates.

Statement of Line



GUEST ARMLESS



GUEST ARMLESS
UPHOLSTERED



GUEST ARM



GUEST ARM
UPHOLSTERED



LOUNGE ARMLESS



LOUNGE ARMLESS
UPHOLSTERED



LOUNGE ARM



LOUNGE ARM
UPHOLSTERED



Options

- Arm and Armless
- Optional Upholstery
- Bolt-Down Plate
- Ballasting
- CAL TB 133 upholstery available

- ✓ TAMPER RESISTANT
- ✓ ANTI-LIGATURE
- ✓ BLEACH CLEANABLE
- ✓ EXTREME DURABILITY
- ✓ GREENGUARD GOLD
- ✓ HEALTHIER HOSPITALS

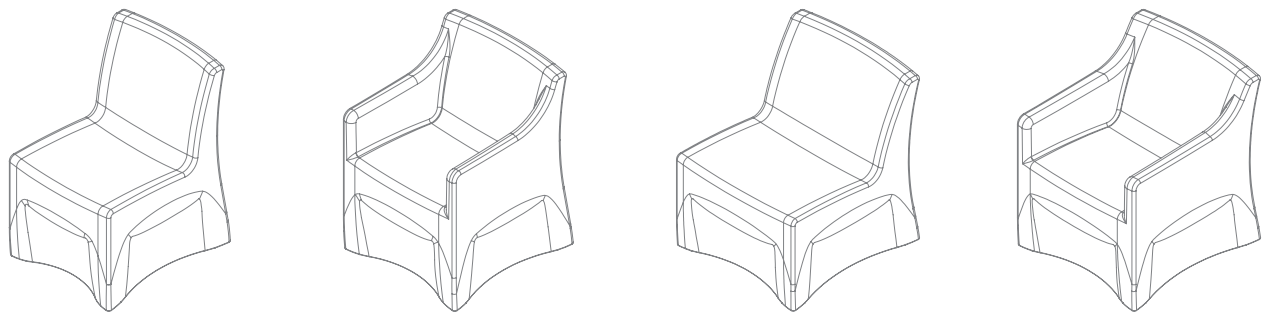

Vesta's attractive residential appearance is an appropriate complement to any interior environment.

Vesta™ is available in several colors and hundreds of upholstery options.

Cushioning is stitched and attached with hidden staples and secure hardware to assist in keeping products safe and tamper-resistant.



Molded Seat Colors

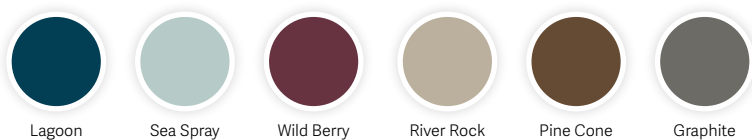



FORTÉ® SERIES



Forté® is the designer series of furniture that is fashioned for comfort, flexibility and durability. With a variety of colors to choose from and an upholstery option for seating, this series is made to humanize intensive-use environments and includes a lounge chair and guest chair that come with or without arms. These products are engineered and proven suitable for daily use in demanding environments.

Statement of Line



GUEST ARMLESS



GUEST ARM



LOUNGE ARMLESS
WOOD LEGS



LOUNGE ARMLESS
STEEL BASE



LOUNGE ARMLESS
MOLDED BASE



LOUNGE ARM
WOOD LEGS



LOUNGE ARM
STEEL BASE



LOUNGE ARM
MOLDED BASE



Options

- Arm and Armless
- Optional Upholstery
- Ganging Kit
- Bolt-Down (Steel & Wood Bases)
- Ballasting (Molded Base)
- CAL TB 133 upholstery available

- ✓ TAMPER RESISTANT
- ✓ BLEACH CLEANABLE
- ✓ EXTREME DURABILITY
- ✓ CONCEALED STAPLES
- ✓ GREENGUARD GOLD
- ✓ HEALTHIER HOSPITALS



Forté Lounge
Wood Legs

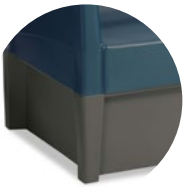

Forté Lounge
Molded Base



Forté Lounge
Steel Base



Molded Seat Colors

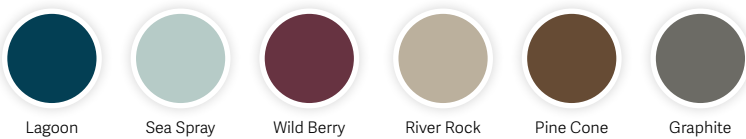

Forté Lounge Wood Legs

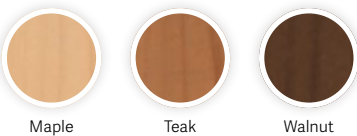

Forté Lounge Molded Base

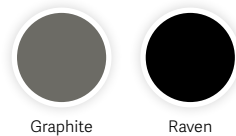

Forté Lounge Steel Base

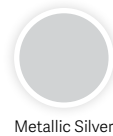



A line of unique furniture that combines superior durability, comfort and style and that includes chair, bench and wedge options that allow for flexible, modular seating arrangements. Hondo Nuevo® is specially designed for facilities where robust products are a must.

Statement of Line



30° ARM CHAIR



30° ARMLESS CHAIR



24° ARMLESS CHAIR



RIGHT ARM CHAIR



LEFT ARM CHAIR



SEAT WEDGE



HIGH BACK CHAIR



BENCH WEDGE



BENCH



FOOT STOOL



CUBE



OTTOMAN



STOOL

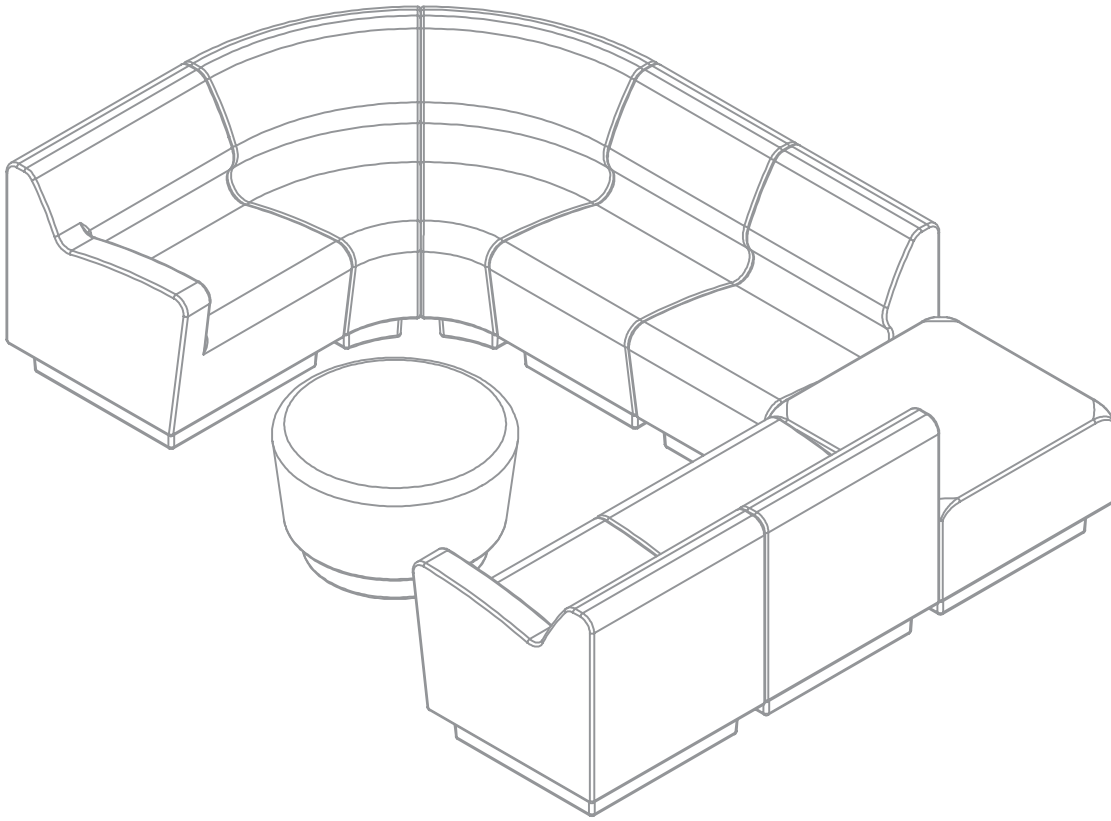

Options
 Bolt-Down
 Ganging Kit
 Locking Ganging Kit

- ✓ ANTI-LIGATURE
- ✓ TAMPER RESISTANT
- ✓ BLEACH CLEANABLE
- ✓ EXTREME DURABILITY
- ✓ ROUNDED EDGES
- ✓ GREENGUARD GOLD

Smooth, exterior surface is impervious to fluids and highly puncture resistant, yet easy to sanitize.

Fabricated drip edge allows moisture to run off the chair and not into the base.

Endless configurations for a flexible design.

Customize your look with three unique base options.

Choose from 5 durable seat colors.



Seat Colors



Molded Wood Grain Legs

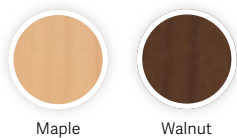

Molded Base

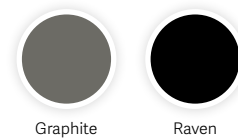

Steel Base





ROCKSMART®



RockSmart™ is a contemporary rocking chair designed from the ground up for soothing comfort, exceptional durability and aesthetic appeal. Its signature one-piece shape is sculpted from rotationally-molded polyethylene for a calming, safe and comfortable rock.

- ✓ TAMPER RESISTANT
- ✓ BLEACH CLEANABLE
- ✓ INFECTION CONTROL
- ✓ SAFE ROCKING
- ✓ EXTREME DURABILITY
- ✓ GREENGUARD GOLD



Colors

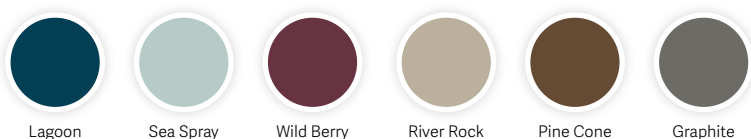

Options

Heavier Weight



TOUGHCARE®



The Toughcare® Series chairs are designed and engineered for critical environments, high traffic areas and intensive use applications. These chairs are rotationally-molded in one-piece and use high-impact polyethylene with UV stabilizers to reduce fading. Toughcare® chair products can be ganged together, bolted down or weighted on-site for added security. All products compliant with the stringent California Technical Bulletin 133 Flammability Test procedure.

Statement of Line

- ✓ ANTI-LIGATURE
- ✓ INFECTION CONTROL
- ✓ EXTREME DURABILITY
- ✓ BLEACH CLEANABLE



ULTRA-MAX
ARMLESS CHAIR



ULTRA-MAX
ARM CHAIR



SLAMMER
STOOL



SLAMMER STOOL
WITH BACKREST

Colors

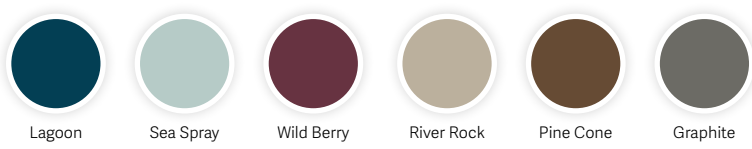

Options

- Ganging Plate*
- Bolt-Down Plate*
- Ballasting*
- *Ultra-Max Chairs Only



GIBRALTAR®



At last, a collection of in-line seating that delivers intensive-use security and durability in a sleek, contemporary design. Gibraltar® is designed to survive the rigors of continuous use – and look great doing it.

- ✓ INFECTION CONTROL
- ✓ BLEACH CLEANABLE
- ✓ EXTREME DURABILITY
- ✓ GREENGUARD GOLD
- ✓ RECYCLABLE PRODUCT
- ✓ HEALTHIER HOSPITALS



Colors

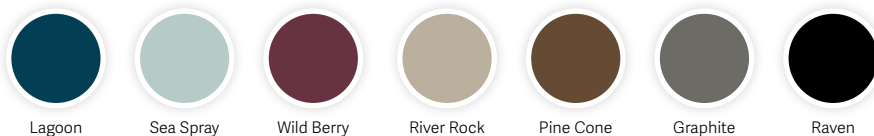

Frame



Options

- End or Divider Arms
- 1, 2, 3 or 4 Seats
- Leveler Glides
- Bolt-Down



BOULDER



Norix Boulder Series Beam Seats have been in use in lobbies and waiting areas throughout the world and are still going strong and looking good. Why? Because they're built to last, with powder coated tubular steel frames, welded steel plate seat supports, washable molded polyethylene seats, super heavy-duty glides and 9 tamper-resistant screws to hold each seat in place.

- ✓ INFECTION CONTROL
- ✓ BLEACH CLEANABLE
- ✓ EXTREME DURABILITY
- ✓ GREENGUARD GOLD
- ✓ RECYCLABLE PRODUCT
- ✓ HEALTHIER HOSPITALS



Colors

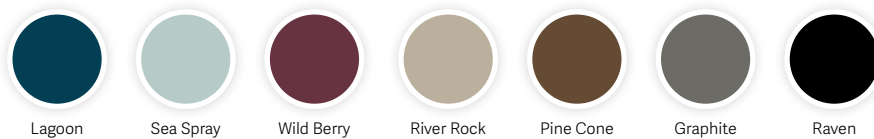

Frame



Options

Armless, End Arms or Divider Arms
3, 4 or 5 Seats
Leveler Glides
Bolt-Down

INTEGRA

Integra chairs are specifically designed for intensive use applications, yet comfortable and lightweight. They're molded in one-piece so you don't have to worry about assembled components coming loose. They're stackable and they pass the rigid California Technical Bulletin 133 Flammability Test.



- ✓ INFECTION CONTROL
- ✓ BLEACH CLEANABLE
- ✓ HEALTHIER HOSPITALS
- ✓ TAMPER RESISTANT
- ✓ EXTREME DURABILITY
- ✓ GREENGUARD GOLD

Colors

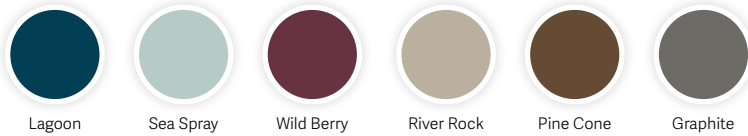

Options

3 Wheel Dolly

PROGRESS

Progress is a passive ergonomic stackable chair. With a living hinge molded into the backrest, Progress is designed to supply a high level of back comfort in both upright and relaxed sitting positions. With or without upholstery, the Progress chair looks good in any environment. Pick from many different fabric grades to go with black legs and you have an attractive combination to accent a training room, a lobby or an office.



- ✓ EXTREME DURABILITY
- ✓ GREENGUARD GOLD
- ✓ HEALTHIER HOSPITALS

Seat Colors

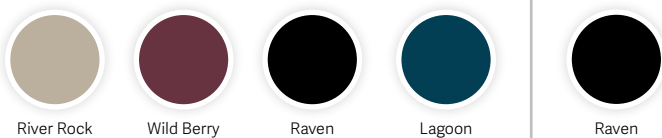

Leg Color



Options

CAL TB 133 upholstery

AFFINITY

Affinity combines a metallic silver frame with hundreds of seat and back options. Available with or without arms, and optional upholstered or wood back, the chair makes a great companion to the broad assortment of Norix® tables. Contrasting fabrics are available for an even more dynamic look. The elegant appearance of Affinity lends itself extremely well to lobbies, recreational spaces, and dining areas.



- ✓ CONCEALED STAPLES
- ✓ FLOOR PROTECTION
- ✓ HEALTHIER HOSPITALS
- ✓ TAMPER RESISTANT
- ✓ STEEL FRAME
- ✓ GREENGUARD GOLD

Wood Back



Maple



Walnut (Stain)

Arm Caps



Raven

Frame



Metallic Silver

Options

Arm or Armless
Wood or Upholstered Back
CAL TB 133 upholstery



WINK™

Modern, colorful, and comfortable, Wink™ has it all. Wink™ will brighten up spaces with its vibrant design and limitless upholstery options. Its playful and curvy construction helps to bring fun to common areas. The one-piece rotationally molded polyethylene frame is impervious to fluids and incredibly impact resistant.



- ✓ INFECTION CONTROL
- ✓ BLEACH CLEANABLE
- ✓ GREENGUARD GOLD
- ✓ EXTREME DURABILITY
- ✓ NON-REMOVABLE GLIDES
- ✓ HEALTHIER HOSPITALS

Colors



Lagoon



Sea Spray



Wild Berry



River Rock



Pine Cone



Graphite

Options

Ganging Kit
Bolt-Down Kit
Ballasting
CAL TB 133 upholstery



RIPTIDE™ SERIES

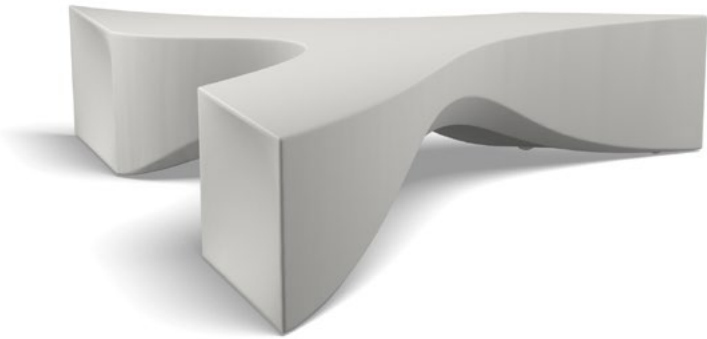

Riptide™ is a fun and inspiring seating solution. This curvy piece is anything but ordinary and livens up spaces for inspiring creativity or providing some much-needed rest and relaxation. This modular bench seat is a stand-alone piece or can be ganged together with the Riptide™ Wishbone for even more thought-provoking and refreshing outdoor spaces.

- ✓ INFECTION CONTROL
- ✓ BLEACH CLEANABLE
- ✓ EXTREME DURABILITY
- ✓ ROUNDED EDGES
- ✓ GREENGUARD GOLD
- ✓ HEALTHIER HOSPITALS

Statement of Line



WISHBONE

BENCH

Colors

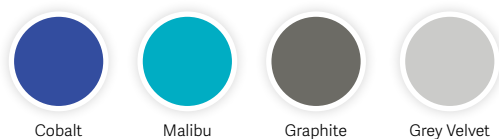

Options

- Bolt-Down Kit
- Ganging Kit
- Ballasting (100 lbs)*
- *On Site Only*

Designed by
Karim Rashid





GOBY® SERIES



Goby® is a one-piece roto-molded chair secure in design and appealing for a unique outdoor experience. The curved design aids in helping to create a zen-like environment for relaxation, meditation, creative thought, and collaboration. Formulated with a high-impact polyethylene (500 lb static load) with enhanced UV resistance, Goby® is perfect for intensive-use environments.

Statement of Line

- ✓ INFECTION CONTROL
- ✓ BLEACH CLEANABLE
- ✓ EXTREME DURABILITY
- ✓ ROUNDED EDGES
- ✓ GREENGUARD GOLD
- ✓ HEALTHIER HOSPITALS



LOUNGE CHAIR



LOVE SEAT



COFFEE TABLE

Colors



Cobalt



Malibu



Graphite



Grey Velvet

Options

Bolt-Down Plates
Ballasting (50 lbs)*
*On Site Only

Designed by
Karim Rashid





KUBE SERIES



Kube is the modern table and chair collection designed to be grouped, moved, and used to optimize any space. Hundreds of configurations are possible, combining the table, bench, arm & armless, and corner Kube pieces. Kube is a one-piece rotationally molded design that creates safe, supervised areas and provides for long-term ROI.

- ✓ INFECTION CONTROL
- ✓ BLEACH CLEANABLE
- ✓ EXTREME DURABILITY
- ✓ ROUNDED EDGES
- ✓ GREENGUARD GOLD
- ✓ HEALTHIER HOSPITALS

Statement of Line



ARMLESS LEFT ARM RIGHT ARM



CORNER BENCH TABLE

Colors



Cobalt Malibu Graphite Grey Velvet

Options

Bolt-Down Ganging Kit Ballasting (50 lbs)



MAX-MASTER®

Engineered for superior strength and durability, the Max-Master® Series is particularly well suited for dining halls and dayrooms where reliable performance is a must. Whether bolted to the floor or freestanding on adjustable glides, the distinctive individual seat/leg design provides superior stability than traditional pedestal tables. Compression molded composite seats, premium table top and unique steel leg design deliver an exceptional table for continuous daily use in challenging environments.



- SECURE MOLDED EDGE
- STEEL-TO-STEEL CONNECTION
- ROUNDED EDGES
- NON-REMOVABLE GLIDES
- EXTREME DURABILITY
- GREENGUARD GOLD

Top Finishes

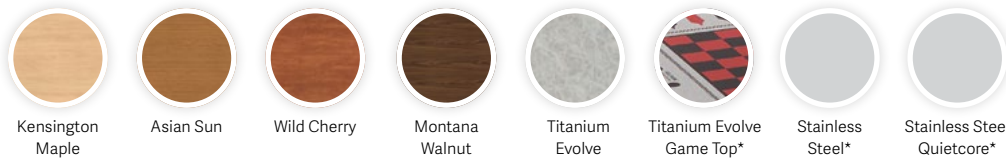

Leg Color

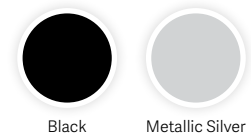

*Available in select styles

Seat Colors

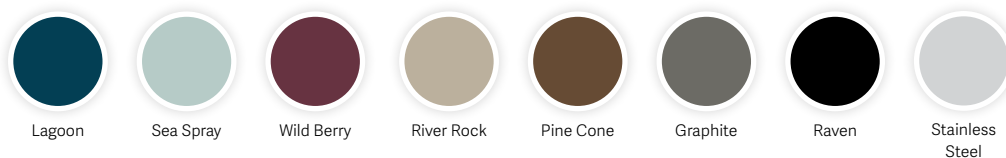

Options

- Bolt-Down
- Clear Leg Protector
- Leg Glides
- ADA

General Dimensions





FORTÉ® CAFÉ



Molded cylindrical hour glass base pairs with Forté® Guest Chairs. Available as a one-piece polymer table or with optional laminated top options. Engineered and proven suitable for daily use in demanding environments.

General Dimensions



- ✓ TAMPER RESISTANT
- ✓ EXTREME DURABILITY
- ✓ ROUNDED EDGE
- ✓ HIGHLY CLEANABLE
- ✓ BALLASTABLE
- ✓ GREENGUARD GOLD

Laminate Tops

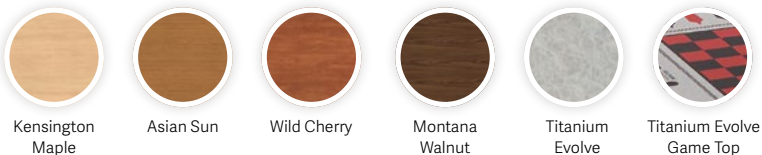

Base Color

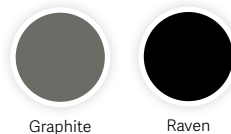

Options

Ballasting



FORTÉ® OCCASIONAL

Freestanding occasional tables can be optionally ganged with lounge seating for intermediate or end tables. Choose one of three base options – wood, steel or molded polymer – and pair with your choice of molded polymer or laminate top with permanently affixed urethane edge. All tops come with embedded T-nuts for a secure steel-to-steel connection.



- ✓ ROUNDED EDGES
- ✓ HIGHLY CLEANABLE
- ✓ TAMPER RESISTANT
- ✓ HEALTHIER HOSPITALS
- ✓ EXTREME DURABILITY
- ✓ GREENGUARD GOLD

Base Options



Wood Legs Molded Plinth Steel Legs

Wood Legs



Maple Teak Walnut

Molded Base



Graphite Raven

Steel Base



Metallic Silver

Options

Ballasting*
*Molded Base Only

Molded Top Colors



Lagoon Sea Spray Wild Berry River Rock Pine Cone Graphite

Laminate Tops



Kensington Maple Asian Sun Wild Cherry Montana Walnut Titanium Evolve

TABLA

Tabla is a laminated table solution that can add residential touches to lobbies, staff areas and any other space in need of a normative accent. Available in two different sizes and in a Standard and Premium version, facilities can choose from four different laminates that can humanize environments that may otherwise be institutional in nature.



- ✓ CONTRABAND RESISTANT
- ✓ HEALTHIER HOSPITALS
- ✓ TAMPER RESISTANT
- ✓ BALLASTABLE

Laminate Tops

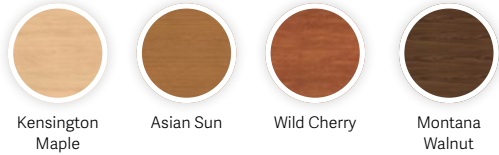

Base Color



Options

Premium or Standard
36" or 18"
Bolt-Down
Ballasting

B-SIDE

B-Side is an ideal companion to any of the Norix roto seating products. B-Side is durable, safe, easy to clean and a natural table or stool. Options available to ballast, bolt-down and add ganging brackets on the square B-Side.

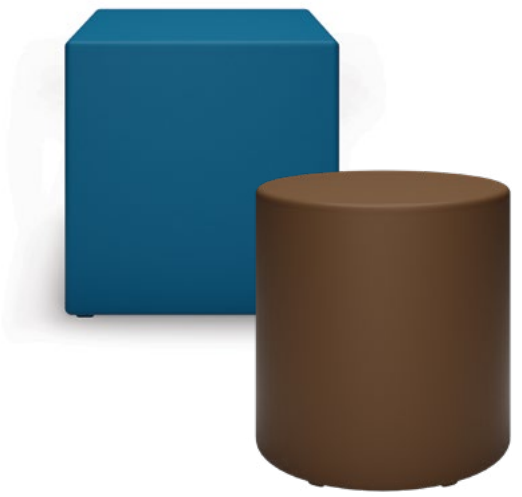

- ✓ TAMPER RESISTANT
- ✓ BLEACH CLEANABLE
- ✓ CONTRABAND RESISTANT
- ✓ EXTREME DURABILITY
- ✓ BALLASTABLE
- ✓ GREENGUARD GOLD

Colors

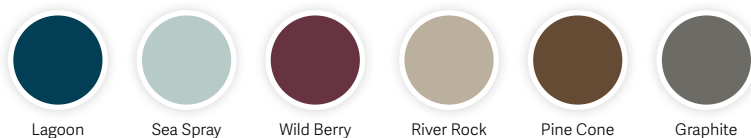

Options

Ballasting
Square or Round



OASIS® SERIES



If your environment demands a more robust solution for cluster seating, your search is over. The new Oasis™ Series is designed and engineered specifically for dayrooms, dining halls and visitation areas. Oasis™ is perfect for situations where users need more back support than traditional stools provide.

- ✓ TAMPER RESISTANT
- ✓ BLEACH CLEANABLE
- ✓ INFECTION CONTROL
- ✓ HEALTHIER HOSPITALS
- ✓ EXTREME DURABILITY
- ✓ GREENGUARD GOLD

General Dimensions

30"x48"

30"x72"

Seat Colors



Lagoon



Sea Spray



Wild Berry



River Rock



Pine Cone



Graphite

Top Finishes



Kensington Maple



Asian Sun



Wild Cherry



Montana Walnut



Titanium Evolve



Titanium Evolve Game Top



Stainless Steel Inlay

Frame Colors



Metallic Silver



Black

Options

- ADA Glides
- Bolt-Down
- Fixed Seats
- Swivel Seats

X-BASE

Years ago, we were challenged to design an institutional-grade table that defined each person's space and hindered the passing of contraband from one individual to another on the opposite side. Our answer was the popular, rugged X-Base Table with its unique "X" base design. Today, the X-Base Table is used in high-security and special needs facilities all across the country.

- ✓ SECURE MOLDED EDGE
- ✓ STEEL-TO-STEEL CONNECTION
- ✓ GREENGUARD GOLD
- ✓ ROUNDED EDGES
- ✓ EXTREME DURABILITY

Laminate Tops

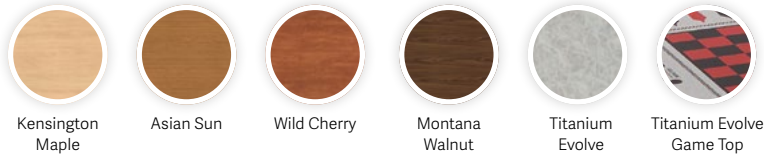

Base Color

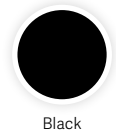

General Dimensions

36"

42"

48"

36"

42"



JUPITER

Sometimes you want a table that is easy to move around. Other times you'd like that table to stay in one place, but you don't want to bolt it to the floor. Enter the Norix Jupiter Table! Jupiter is designed to be weighted on site to maintain space flexibility and allow for efficient floor maintenance as the needs of an environment change.

- ✓ TAMPER RESISTANT
- ✓ ROUNDED EDGES
- ✓ HIGHLY CLEANABLE
- ✓ EXTREME DURABILITY
- ✓ BALLASTABLE
- ✓ GREENGUARD GOLD

Laminate Tops

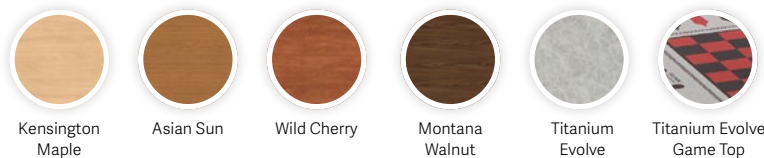

Base Color

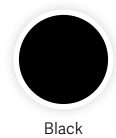

Options

Ballasting

General Dimensions

36"

42"

48"

36"

42"



LEG STYLE

When you start with 4" diameter 14 gauge tubular steel legs fully welded to 1/4" steel mounting plates, you end up with an incredibly strong, stable and durable table. The legs are joined to the top using tamper-resistant screws connected to embedded T-nuts, for a secure steel-to-steel connection. Optional 2 1/2" legs provide an attractive residential alternative. Legs are solid as a rock. The Leg Style Table won't wobble or tip. Lean on it with all your weight. That's peace of mind.

General Dimensions

36" 42" 48"

30"x72" 30"x96"



- SECURE MOLDED EDGE
- STEEL-TO-STEEL CONNECTION
- HEALTHIER HOSPITALS
- ROUNDED EDGES
- EXTREME DURABILITY
- GREENGUARD GOLD

Laminate Tops

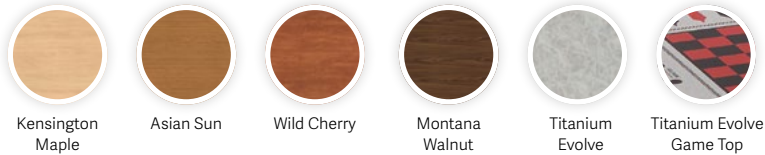

Leg Color

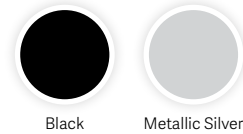

Options

2" or 4" Legs
Bolt-Down Configuration

MULTI-PURPOSE

Most commercial tables are put together with easily removed screws, nuts, bolts, screw-out glides and snap-on parts. Norix created the Multi-Purpose Series of tables specifically to avoid those attributes so you don't have to think about the possibility of injury by altered furniture parts.

- TAMPER RESISTANT
- STEEL-TO-STEEL CONNECTION
- HIGHLY CLEANABLE
- GREENGUARD GOLD
- HEALTHIER HOSPITALS



Laminate Tops

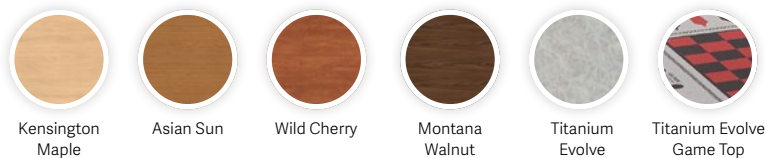

Leg Color

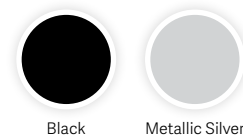

General Dimensions

36" 42" 36" 42"

18"x60" 24"x60" 30"x60"



HEX-IT SERIES

Oh Hex! No, we aren't commanding you to put a spell on it. The name Hex-It actually is derived from the hexagonal shape of this kids seating and table solution from Norix®. This multi-function marvel allows you to flip the product on one side and use it as a stool. Flip it on its other side and you have a table. It's an ideal kids seating solution with a fun shape that's ready to be configured to your space.



- ✓ INFECTION CONTROL
- ✓ EXTREMELY DURABLE
- ✓ ROUNDED EDGES
- ✓ HEALTHIER HOSPITALS
- ✓ BLEACH CLEANABLE
- ✓ GREENGUARD GOLD



Colors

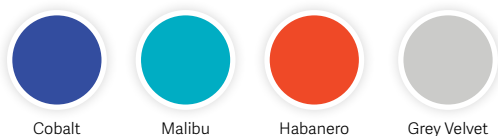

A-MAZE

A kids furniture product from Norix, A-Maze™, is a one-seat wonder due to the endless configurations that can be created. Its four colors, secure construction and playful shape make this perfect for play areas or any other place where children may gather. This light-weight product can be moved and reconfigured as needed and is applicable to high-traffic and constant-use areas.

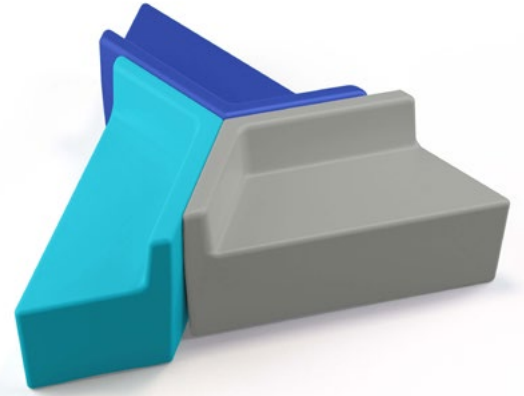

- ✓ INFECTION CONTROL
- ✓ EXTREMELY DURABLE
- ✓ HEALTHIER HOSPITALS
- ✓ ROUNDED EDGES
- ✓ BLEACH CLEANABLE
- ✓ GREENGUARD GOLD

Colors

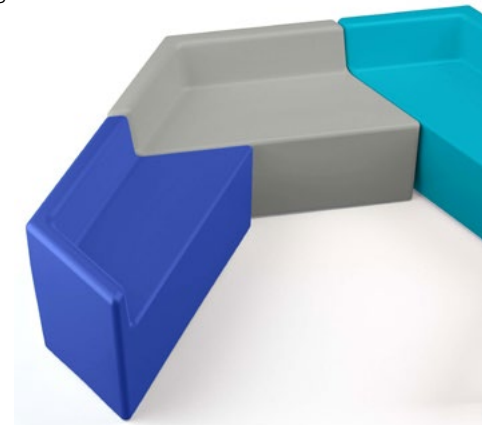
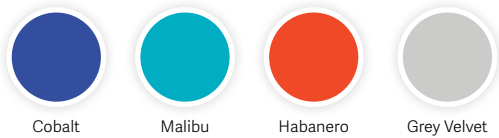

ELLE SERIES

The Elle Series Chair and Table is a fairy-tale take on kids furniture for facilities looking for a seating solution that is fun and safe for use by children. Both Elle products are available in four colors and are highly durable.



- ✓ INFECTION CONTROL
- ✓ EXTREMELY DURABLE
- ✓ HEALTHIER HOSPITALS
- ✓ ROUNDED EDGES
- ✓ BLEACH CLEANABLE
- ✓ GREENGUARD GOLD

Colors

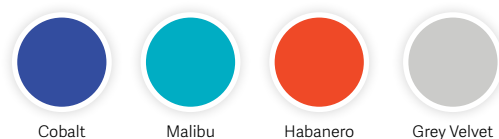

MATTRESSES

Custody® Sealed Seam Mattresses feature 100% sealed seams that are radio frequency welded and guaranteed not to break – for enhanced hygiene, security and durability.

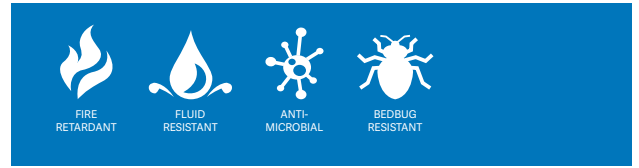

CUSTODY NORIX BLUE



Color



Norix Blue



Sealed Seam



Norix Blue is a durable mattress with infection control features that make it suitable for daily use in critical environments. It features 100% sealed seams for unsurpassed seam strength and a durable polyurethane coated cover. Day in, day out, Norix Blue will perform well above your expectations.

CUSTODY SILVER SECURE



Color



Silver



Ripstop,
Sealed Seam



Silver Secure is the perfect mattress for those facilities needing more durability and security than what is found in your typical corrections mattress. It is constructed with a durable polyurethane-coated cover with reinforcing ripstop scrim, along with enhanced break strength for added security. An applicable product for the intensive-use found in correctional environments.

CUSTODY BLACK MAX



Color



Black



Ripstop, Sealed,
Stitched Seam



Black Max is a highly durable mattress and is suitable for the most extreme use spaces in your facility. That's because the mattress is constructed with 100% sealed seams that are reinforced with maximum security stitching for unsurpassed seam strength. It's also constructed with an extremely impervious, polyurethane coated cover with reinforcing ripstop scrim. All of this makes Black Max highly resistant to constant-use, bodily fluids, bed bugs and other challenges you may find in correctional setting.

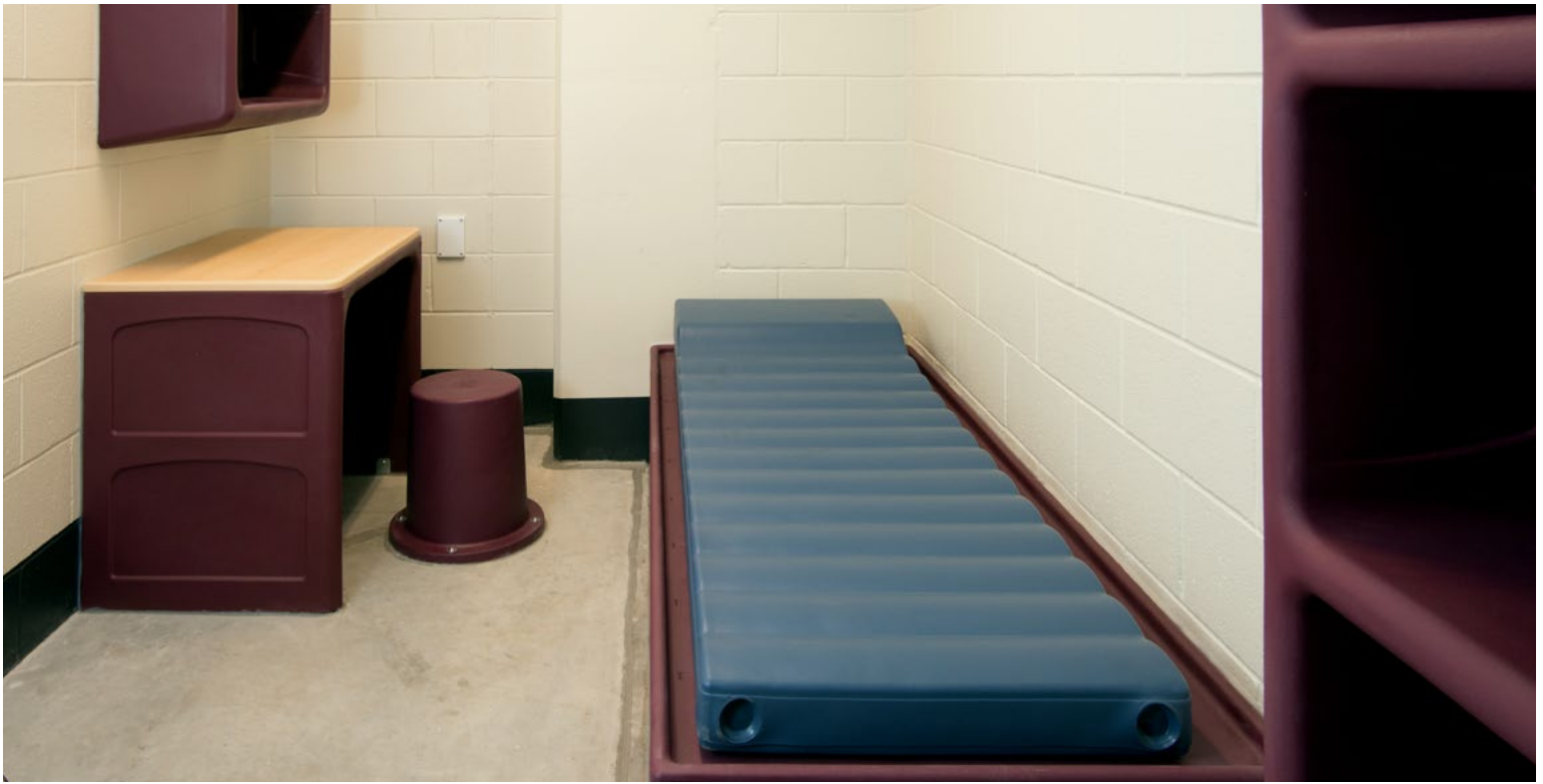

CUSTODY NORIX CLEAR



Color



Clear



Sealed Seam



Custody Clear Sealed Seam Mattress is polyurethane coated and sealed with radio frequency welding. The translucent design reduces the capability for contraband storage, and the sealed seams prevent bed-bugs and bodily fluid absorption for greater infection control. The unique air string core and upgraded polyurethane coated polyester cover create long-lasting durability well beyond the standard correctional mattress.

CUSTODY MARATHON



Color



Slate

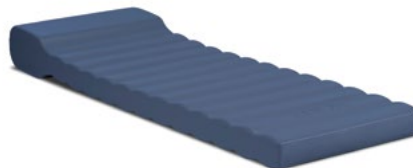

Our Marathon mattress is the most durable correctional mattress on the market and can stand up to the most extreme spaces in your facility. Truly innovative, the product has a seamless exterior that is rotationally-molded in one-piece, not sewn or stitched. The rotationally-molded vinyl skin is 200 mm thick and is filled with soft polyurethane foam for comfort. An integrated double-sided pillow adds safety and security while the heavy weight of the product deters it being used as a barrier or weapon. Non-absorbent and fluid resistant. No seams for bedbugs to invade. Like its name implies, Marathon goes the distance.



ATTENDA®



Correctional professionals have long recognized that traditional furniture is completely unsuitable for their critical environments. The Attenda® Series is designed to provide the strength, safety and cleanability required for the daily rigors of institutional living — in a sleek, contemporary look. The key to Attenda's strength and durability is its advanced construction. Molded-in specially formulated, high-impact, polyethylene, each Attenda® product is structurally enhanced for increased strength and durability.

Statement of Line





Options

Varies by product. See specification sheet for details.

- ✓ INFECTION CONTROL
- ✓ TAMPER RESISTANT
- ✓ CONTRABAND RESISTANT
- ✓ EXTREME DURABILITY
- ✓ BLEACH CLEANABLE
- ✓ ANTI-LIGATURE

They are solid as a rock, yet feature seamless construction with rounded corners for added safety and security.

Each piece is designed to be attached flush to the wall or floor and can be easily sanitized.

Attenda's unparalleled performance features make it uniquely suited for constant-use environments.



Colors



Optional Laminates

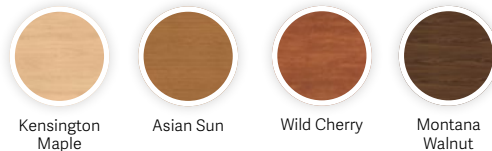



TITAN[®] SERIES



Looking for residential furniture that can endure years of intensive-use in your facility's demanding environment? The Titan[®] Series from Norix – a complete line of steel case goods that combines functional versatility with the institutional durability of all-steel construction. There's no substitute for the strength, safety and durability of steel furniture, and Titan[®] has emerged as the product of choice in institutional settings.

Statement of Line





Options
 Varies by product. See specification sheet for details.

- ✓ INFECTION CONTROL
- ✓ TAMPER RESISTANT
- ✓ STEEL CONSTRUCTION
- ✓ SECURE, DURABLE DRAWERS
- ✓ BED BUG RESISTANT
- ✓ GREENGUARD GOLD

Titan® was designed to perform in the most challenging environments.

Titan® is an ideal choice to replace problem wooden furniture. Titan® products are heavy and heavy duty.

You don't have to worry that they'll be broken through intensive-use.

Steel stands the test of time, and provides the best value option. Titan® delivers worry-free performance.



Steel Colors

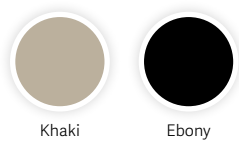

Laminate

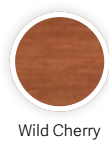

Optional Steel Colors *Minimums Apply

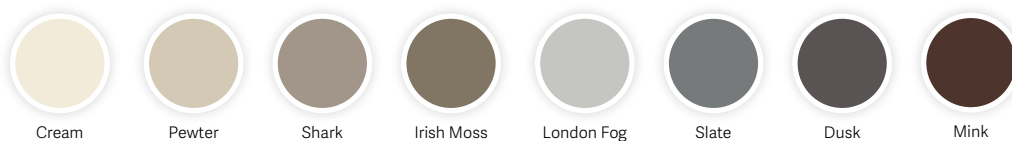



STACK-A-BUNK®

Overcrowded facilities and emergency temporary bunking can be a serious problem if you aren't prepared. The Norix® Stack-A-Bunk® solves the problem with a washable and stackable sleep surface.



- ✓ STACKABLE
- ✓ BLEACH CLEANABLE
- ✓ INFECTION CONTROL
- ✓ BED BUG RESISTANT

Statement of Line



STANDARD



X-LARGE



Colors



Lagoon
**Standard Only*



River Rock
**X-Large Only*



DURAVISION™



DuraVision™ polycarbonate mirrors from Norix are designed specifically for the challenging conditions found in correctional facilities. The strength of polycarbonate combined with a solid, full foam backing and a unique steel frame design ensures these mirrors exceed the breakability and tamper resistance of any other product on the market.

- ✓ ANTI-LIGATURE
- ✓ EXTREMELY DURABLE
- ✓ TAMPER RESISTANT
- ✓ GREENGUARD GOLD

Statement of Line



FULL DOME



HALF DOME



QUARTER DOME



WALL ROUND



WALL RECTANGLE

Frame

Mirror



Cream



Silver

INTELESTATION®



You've made the decision to implement non-contact visitation to streamline the processing of inmate and visitor contact. Now you need to consider how to protect your investment in the expensive video and voice communications equipment that will be installed in your facility.

Norix offers the most complete range of secure cabinets designed, engineered and constructed specifically for non-contact visitation.

- ✓ DURABLE LAMINATE
- ✓ TAMPER RESISTANT
- ✓ HEAVY DUTY BASE
- ✓ STEEL-TO-STEEL CONNECTIONS
- ✓ STEEL CONSTRUCTION
- ✓ THOUGHTFULLY DESIGNED

Statement of Line



LAMINATE FLOOR MOUNT



LAMINATE FLOOR MOUNT WITH SEATS



LAMINATE BACK-TO-BACK



LAMINATE WALL MOUNT



LAMINATE WALL MOUNT WITH SEATS



LAMINATE CUBICLE



STAINLESS STEEL FLOOR MOUNT



STAINLESS STEEL FLOOR MOUNT WITH SEATS



STAINLESS STEEL BACK-TO-BACK



STAINLESS STEEL WALL MOUNT



STAINLESS STEEL WALL MOUNT WITH SEATS

Seat Finishes



Lagoon



Sea Spray



Wild Berry



River Rock



Pine Cone



Graphite



Raven



Stainless Steel

Cabinet Finishes



Black Laminate



Stainless Steel

Leg Finishes



Black

Options

Single, Double or Triple units*
*Laminate cabinets only



DETENTION FURNITURE



Ironman® Steel Bunks

Single bunks, Double bunks, Floor-mount or wall-mount. Fully welded or bolt-together with tamper-resistant hardware. With or without attached slide rails for the exclusive Norix® property boxes. Constructed for quality and reliability. Not built down to meet a low price.



Citadel Property Storage

Next generation product from Norix®, industry leader in detention-grade furnishings and equipment. Rounded edges for enhanced safety, security and structural integrity.



Tank Box Property Storage

Specially formulated structural plastic, pound for pound, twice as rigid as steel. Resistant to impact, stains and scratches. Won't rust. Passes CAL TB 133. One-piece, injection-molded, maintenance free construction.



Cuff Bench

Floor mount steel benches with cuff rings for transit and intake areas.



Floor-Mount Stool

The Ironman® Floor Mount Stool provides unsurpassed durability with 11 gauge tubular steel and 1/4" thick steel mounting plates. Seats are available in Super Slammer Stone® or stainless steel to match other Norix® cell furniture.

ACCESSORIES/WASHROOM



Pistol Locker

Keep your officers' pistols in a locked steel cabinet. Monitor the cabinet if you want to, but the solid construction will convince you that supervision is an option.



Speaker Port

6" diameter cast stainless steel port provides natural voice transmission. Level III bullet-resistant.



Package Pass

The stainless steel Package Pass has interconnected doors that operate like a sally port. One door must be closed before the other can be opened. Vision panel in rear door allows operator to view contents of the unit.



Pass Hopper

Cut, formed and welded stainless steel assembled to fit countertop, window or wall openings. Steel and stainless steel on exposed surfaces. #4 finish stainless steel.



Ball Clothes Hooks

Single collapsible safety hooks or groups of four with optional 8" deep x 18" long bookshelf. Ball and stem style in stainless only.



Towel Hooks

Holds towels or clothing articles safely without the use of protruding pegs or hooks. The surface mounted towel hooks come in stainless steel. Choose from a single towel hook or groups of four.



ADA Shower Seat

Stainless steel detention-grade recessed shower seat. ADA version meets ADA 4.21.3 & 4.26.3 requirements for L-Shape Shower Seats.



Security Grab Bars

The Security Grab Bar has a safety gap-filler between the round tube bar and the wall. Styles in stainless steel. Standard sizes in 18", 24", 36", 42" and 48". "L" shape bar also available.



Toilet Paper Holder

Front mount toilet paper holder is available in easy-to-clean stainless steel.



Wall Mirrors

One-piece #430 stainless steel. Highly polished #8 finish. Three standard sizes including ADA (11.3"x9.5", 17.3"x11.3", 38"x11.3"). Mount direct to wall or with an optional 1/4" thick steel backer plate. Optional embed plate also available.



Recessed Shelf

No sharp corners or edges protruding from the wall to inflict injury. The chase-mounted recessed shelf comes in easy-to-clean stainless steel.

INSTALLATION SERVICES



Norix® correctional furniture is safe, secure and built to last. Our furniture also provides outstanding long-term value and peace of mind for your staff. For facilities not using contractors or consultants, it makes sense to reinforce the benefits of the furniture with a installation from Norix®.

Benefits of Installation Services:

- Expert installation services, performed by professionals experienced in all facility installations.
- Complex installation capabilities, including field drilling into concrete, secure bolt-down and application of security caulk.
- All labor, installation hardware and materials included.
- Seamless transaction on same purchase order as furniture.
- Reinforces product warranty.

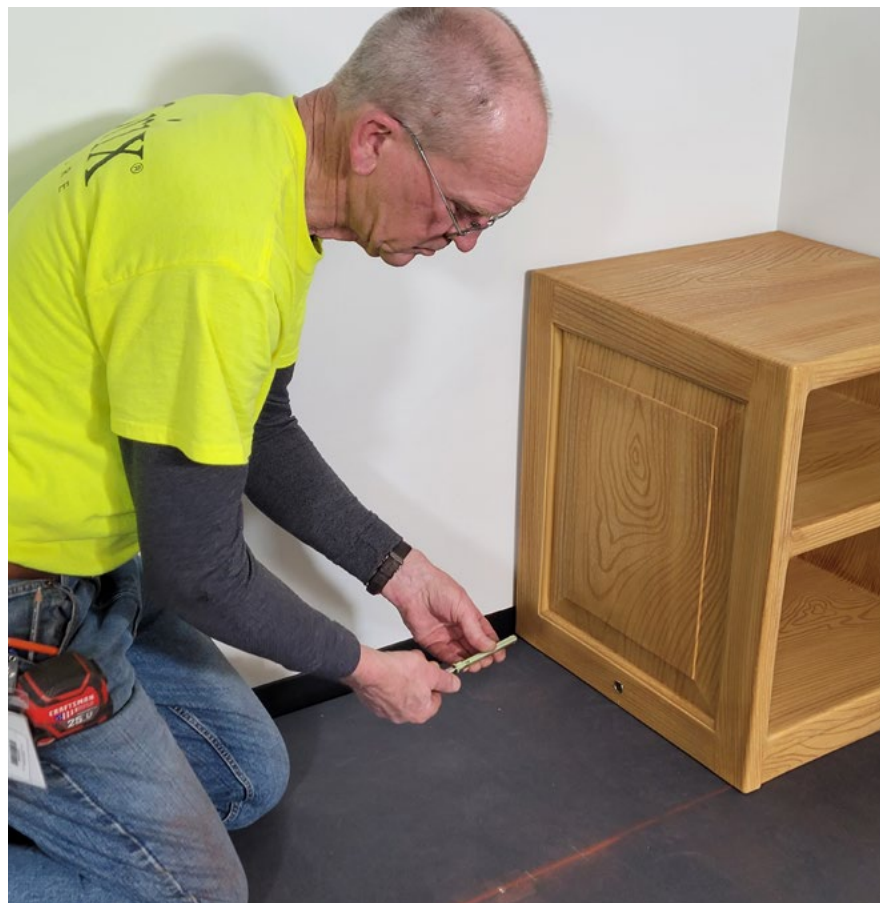

AT NORIX, WE DESIGN INNOVATIVE,
ROBUST FURNITURE THAT MEETS THE
REAL-WORLD NEED FOR HUMANIZING
CHALLENGING ENVIRONMENTS.



Individual attributes vary by product. See specification sheet for details

NORIX[®]
J U S T I C E

One Innovation Drive, West Chicago, Illinois 60185
Phone: 630-231-1331 / Toll Free: 800-234-4900 / Fax: 630-231-4343
Printed 2/22 furniture@norix.com ©2022 Norix Group, Inc.

NORIX.COM