

# BEHAVIORAL HEALTHCARE

F U R N I T U R E

# BEHAVIORAL HEALTHCARE

F U R N I T U R E



Norix is a leading provider of behavioral healthcare furniture solutions that are specially designed for facilities looking to create safe and secure environments. Designed and engineered specifically for critical applications, Norix psychiatric furniture is ideally suited for facilities unwilling to compromise on safety or humanizing aesthetics in pursuit of a therapeutic environment.

Our unique mental healthcare furniture includes anti-ligature products designed after consultation with field-experienced practitioners who are well-versed in safety requirements for patients and staff. Our durable furniture products are easy to clean, tamper-resistant and resilient to cleaning agents and fluids.

Select from a variety of special needs furniture including behavioral healthcare tables, beds and seating to suit your requirements for safety, security and the creation of a therapeutic and humanizing environment.

# TABLE OF CONTENTS

3 Bedroom Furniture

9 Mattresses

11 Seating

31 Tables

39 Outdoor Furniture

43 Kids Furniture

46 Mirrors

47 Accessories

48 ADA Products



# PRODIGY® SERIES



Crafted in a specially formulated polymer with proprietary innovations to deliver superior durability, maintenance free cleanability and humanizing aesthetic appeal. Each piece is uniquely fashioned with specialized TruGrain™ polymer to replicate natural wood and deliver a residential, non-institutional appearance.

## Statement of Line



PLATFORM BED



NIGHTSTAND



OPEN CHEST



DESK



WARDROBE



**Options**  
 Open or enclosed bottom bed  
 Bed Restraint Rings  
 Ballasting  
 Molded and SafeDoor wardrobe doors

- ✓ INFECTION CONTROL
- ✓ ANTI-LIGATURE
- ✓ EXTREMELY DURABLE
- ✓ TRUGRAIN™
- ✓ HOME-LIKE LOOK
- ✓ CONCEALED HARDWARE

### Therapeutically Attractive

Attractive wood grain appearance to enhance the calming familiarity of a home-like environment.

### Designed for Safety

Superior to wood in infection-control and ligature, fluid, tamper, infestation and contraband resistance. Concealed anchoring.

### Durable

Structurally reinforced for superior durability, impact resistance and security.

### Maintenance-Free

Seamless one-piece construction delivers unmatched cleanability and long-term, maintenance-free performance.

### Environmentally Responsible

Recyclable polymer is made responsibly with recycled content.



#### Colors



Harvest



Java

#### SafeDoor Prints



Harvest



Java



# ATTENDA® SERIES



The Attenda® Collection is designed to provide the strength, safety, and cleanability required for institutional living's daily rigors — in a sleek, contemporary look. The key to Attenda's strength and durability is its advanced construction. Molded-in specially formulated, high-impact, fire-retardant polyethylene, each Attenda product is structurally enhanced for increased strength and durability.

## Statement of Line

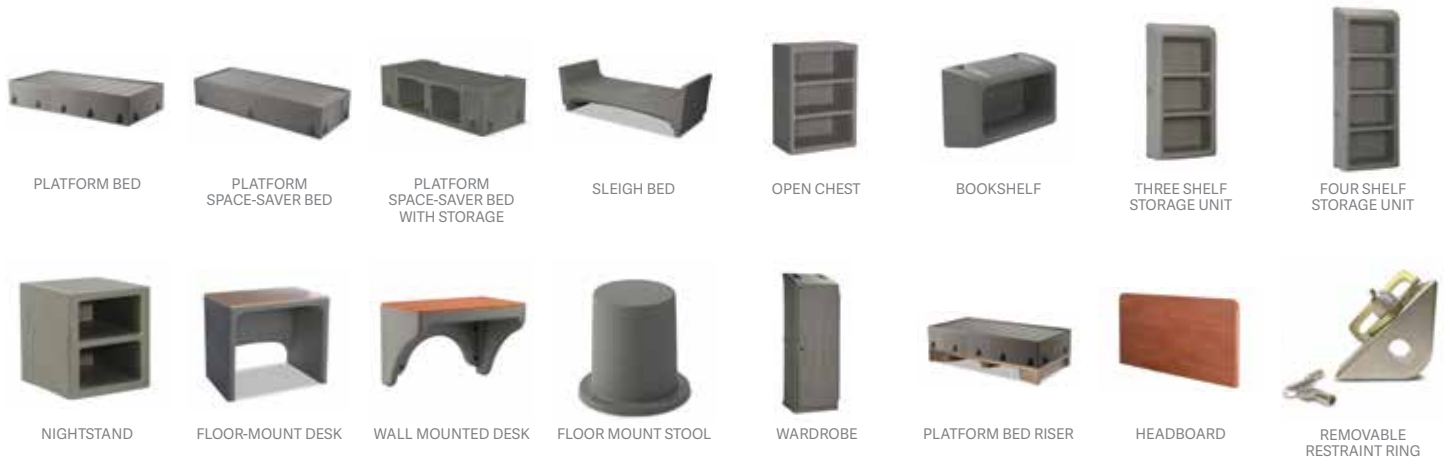



### Options

Platform Bed Restraint Rings,  
Platform Bed Bottom Closure,  
No Floor Mount Holes,  
Headboard, Bed Riser,  
SafeStore

- ✓ INFECTION CONTROL
- ✓ TAMPER RESISTANT
- ✓ EXTREMELY DURABLE
- ✓ CONTRABAND RESISTANT
- ✓ BED BUG RESISTANT
- ✓ ANTI-LIGATURE

Your maintenance staff knows that fluid absorption can wreak havoc with furniture and create a hazardous environment. Attenda's rugged, exterior skin is seamless and impervious to liquids – from bodily fluids to industrial cleaners. The non-absorbent, polymer construction simply leaves no place for fluids to go. Chronic maintenance problems are washed away.



#### Colors



Pine Cone



River Rock



Lagoon



Graphite

#### Laminates



Wild Cherry



Kensington  
Maple



Asian Sun



Montana  
Walnut





# SAFEHOUSE® SERIES



The Safehouse® Series combines safety and durability – in a homelike all-wood collection. After research and consultation with behavioral healthcare professionals, Norix designed the Safehouse collection to provide a warm, yet secure haven for residents – with client safety as the primary consideration.

## Statement of Line



PLATFORM BED



CAPTAIN BED



NIGHTSTAND



3 SHELF CHEST



DESK



WARDROBE



## Options

Bed Headboard  
Bed Bottom Closure Panel  
Bed Restraint Rings

- ✓ ANTI-LIGATURE
- ✓ TAMPER RESISTANT
- ✓ EXTREMELY DURABLE
- ✓ CONTRABAND RESISTANT
- ✓ HEALTHIER HOSPITALS



With built-in safety features like sloped tops, rounded edges and SafeJoint™ concealed joinery, Safehouse offers practitioners peace of mind, plus the therapeutic appeal of real wood. Norix exclusive Dura-Ply™ construction ensures that Safehouse products will stand up to the demands of your challenging environment. 10-year limited replacement warranty for defects in materials and workmanship.



## Colors



Oak



Cherry



# MATTRESSES

Remedy Series mattresses feature 100% sealed seams that are radio frequency welded and guaranteed not to break – for enhanced hygiene, security and durability.

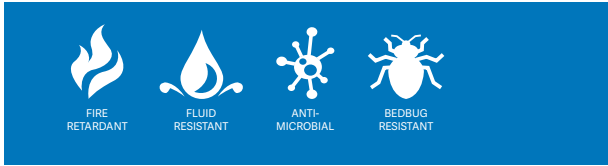

## REMEDY NORIX BLUE



Color



Norix Blue

Available Sizes

29"W x 77"L x 6"H	36"W x 75"L x 6"H
30"W x 75"L x 6"H	36"W x 80"L x 6"H
30"W x 79"L x 6"H	38"W x 82"L x 6"H



Sealed Seam

Ideally suited for Behavioral Healthcare environments. Foam core for cushioned comfort with no inner springs. Separate pillow and wedge mattress options available. Polyurethane coated cover with welded seams for enhanced hygiene and durability.

## REMEDY SILVER SECURE



Color



Silver Secure

Available Sizes

29"W x 77"L x 6"H	36"W x 75"L x 6"H
30"W x 75"L x 6"H	36"W x 80"L x 6"H
30"W x 79"L x 6"H	38"W x 82"L x 6"H



Riptop,  
Sealed Seam

Silver Secure is the perfect mattress for those facilities needing more durability and infection control than what is found in your typical healthcare mattress. It's constructed with a durable polyurethane-coated cover with reinforcing riptop scrim, along with enhanced break strength for added security.

### Options

3 security levels to choose from based on environment needs

- ✓ SECURE SEALED SEAMS
- ✓ FLUID RESISTANT COVER
- ✓ BED BUG RESISTANT
- ✓ CONTRABAND RESISTANT



## REMEDY BLACK MAX



#### Color



Black Max

#### Available Sizes

29"W x 77"L x 6"H	36"W x 75"L x 6"H
30"W x 75"L x 6"H	36"W x 80"L x 6"H
30"W x 79"L x 6"H	38"W x 82"L x 6"H



Ripstop, Sealed,  
Stitched Seam

Black Max is our most durable mattress and is suitable for the most extreme-use spaces in your facility. That's because the mattress is constructed with 100% sealed seams that are reinforced with maximum security stitching for unsurpassed seam strength. It's also constructed with an extremely impervious, polyurethane coated cover with reinforcing ripstop scrim.

A MATTRESS  
FOR ANY  
SITUATION





# TORO LOUNGE



## Warmth of Wood, Performance of Polymer

Innovative durability meets traditional design with the Toro Lounge Chair from Norix Furniture. The classic look of Toro blends into a multitude of environments to help create a warm and rich ambiance, complete with easy to sanitize surfaces and sturdy construction.







**Options**  
 Bolt-Down  
 Ganging Kit  
 Factory Ballasting (50lbs)

- ✓ TAMPER RESISTANT
- ✓ GREATER INFECTION CONTROL
- ✓ MANUFACTURED IN A LEED GOLD FACILITY
- ✓ RECYCLED CONTENT
- ✓ EXTREMELY DURABLE
- ✓ BALLASTABLE
- ✓ SUPERIOR TO WOOD

Toro owes its unique durability characteristics to TruGrain™. TruGrain™ polymer mimics the warm traditional look of natural wood without the typical drawbacks such as chipping, deterioration, delamination, and ability to withstand hospital-grade cleaners. TruGrain™ is the result of years of research and development to create a realistic representation of wood complete with a natural texture and color striations. Initial impressions are universal, with many reporting that TruGrain™ is nearly indecipherable from wood.

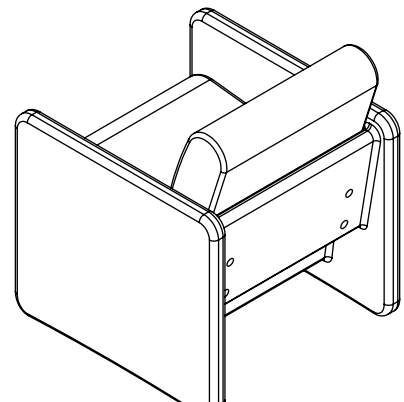
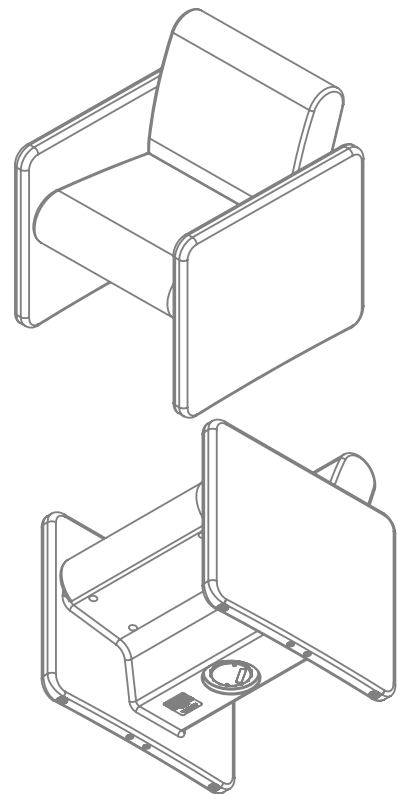

Seat Colors



Harvest

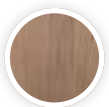

Java



# AFFINITY™ SERIES



Affinity. A natural liking for, or attraction to a person, idea, or thing. That thing from Norix is a chair, but not just any chair. Affinity represents the great length Norix engineers have gone to create a chair that blends attractive form, comfort, versatility, and reliability.



Statement of Line





## Options

CAL TB 133 Upgradeable Upholstery

- ✓ TAMPER RESISTANT
- ✓ CONCEALED STAPLES
- ✓ STACKABLE DESIGN
- ✓ FULLY WELDED FRAME
- ✓ GREENGUARD GOLD
- ✓ HEALTHIER HOSPITALS



Affinity combines a metallic silver frame with hundreds of upholstery seat and back options. Available with or without arms, and optional upholstered or wood back, the chair makes a great companion to the broad assortment of Norix tables. Contrasting fabrics are available for an even more dynamic look. The elegant appearance of Affinity lends itself extremely well to lobbies, meeting spaces, and dining areas.



### Wood Back Color Options



Walnut (Stain)

Maple

### Urethane Arm Caps



Black

### Frame



Steel



# ELEMENT™ SERIES



Element™ is a designer-friendly series of lounge furniture that provides facilities with reliable performance. Mix and match the Element™ Lounge Chair, Love Seat and Sofa throughout your facility depending upon the needs of spaces.

- TAMPER RESISTANT
- HEALTHIER HOSPITALS
- EXTREME DURABILITY
- GREENGUARD GOLD
- CONCEALED STAPLES

## Statement of Line



LOUNGE CHAIR



LOVE SEAT



SOFA

Arm Cap/Feet



Options

CAL TB 133 upholstery available

# HARMONY™ SERIES



The Harmony Series blends form and function to deliver the unique combination of exceptional durability and a residential look for facilities that need humanizing products for their challenging environments. Limited lifetime warranty for structural integrity. In spite of that rugged interior, the Harmony Series is elegant, versatile and aesthetically pleasing.

- ✓ TAMPER RESISTANT
- ✓ HEALTHIER HOSPITALS
- ✓ EXTREME DURABILITY
- ✓ GREENGUARD GOLD
- ✓ CONCEALED STAPLES
- ✓ STURDY STEEL FRAME

## Statement of Line



ARM CHAIR  
SQUARE BACK



ARM CHAIR  
ROUND BACK



LOVE SEAT  
SQUARE BACK



LOVE SEAT  
ROUND BACK



BARIATRIC  
CHAIR



SOFA  
SQUARE BACK



SOFA  
ROUND BACK



ARMLESS  
CHAIR



HIGH BACK  
CHAIR



2 SEAT BENCH



3 SEAT BENCH



COFFEE TABLE



END TABLE

### Arm Cap/Feet



Raven

### Table Top Laminate



Kensington  
Maple



Asian Sun



Wild Cherry



Montana  
Walnut

### Table Base



Maple



Teak



Walnut

### Options

Round or Square Back  
Full or Short Apron  
Clean Out or Standard Fit  
Open or Closed Bottom  
CAL TB 133 Upholstery





# FORTÉ® LOUNGE



Forté® is the designer series of furniture that is fashioned for comfort, flexibility and durability. With a variety of colors to choose from and an upholstery option for seating, this series is made to humanize behavioral health environments and includes a lounge chair and guest chair that come with or without arms. These products are engineered and proven suitable for daily use in demanding environments.

## Statement of Line



ARMLESS CHAIR  
WOOD LEGS



ARMLESS CHAIR  
STEEL BASE



ARMLESS CHAIR  
MOLDED BASE



ARM CHAIR  
WOOD LEGS



ARM CHAIR  
STEEL BASE



ARM CHAIR  
MOLDED BASE



**Options**

Arm and Armless  
 Ganging Kit  
 Bolt-Down (Steel & Wood Bases)  
 Ballasting (Molded Base)  
 CAL TB 133 upholstery available

- ✓ TAMPER RESISTANT
- ✓ INFECTION CONTROL
- ✓ EXTREME DURABILITY
- ✓ CONCEALED STAPLES
- ✓ GREENGUARD GOLD
- ✓ HEALTHIER HOSPITALS



Wood Legs



Steel Base

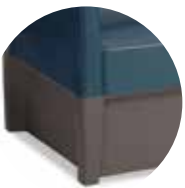

Molded Base



**Molded Seat Colors**



**Wood Legs**

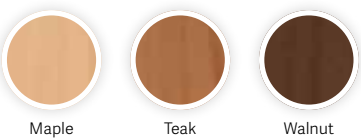

**Molded Base**

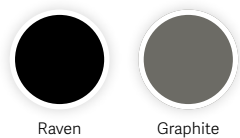

**Steel Base**





# HONDO NUEVO®



A line of unique furniture that combines superior durability, comfort and style and that includes chair, bench and wedge options that allow for flexible, modular seating arrangements. Hondo Nuevo® is specially designed for facilities where robust products are a must.

## Statement of Line



30° ARM CHAIR



30° ARMLESS CHAIR



24° ARMLESS CHAIR



LEFT ARM CHAIR



RIGHT ARM CHAIR



SEAT WEDGE



HIGH BACK CHAIR



BENCH WEDGE



BENCH



CUBE



OTTOMAN



STOOL



FOOT STOOL





**Options**  
 Bolt-Down  
 Ganging Kit  
 Locking Ganging Kit

- ✓ ANTI-LIGATURE
- ✓ TAMPER RESISTANT
- ✓ BLEACH CLEANABLE
- ✓ EXTREME DURABILITY
- ✓ ROUNDED EDGES
- ✓ GREENGUARD GOLD

Smooth, exterior surface is impervious to fluids and highly puncture resistant, yet easy to sanitize. Fabricated drip edge allows moisture to run off the chair and not into the base.

Endless configurations for a flexible design. Customize your look with three unique base options.

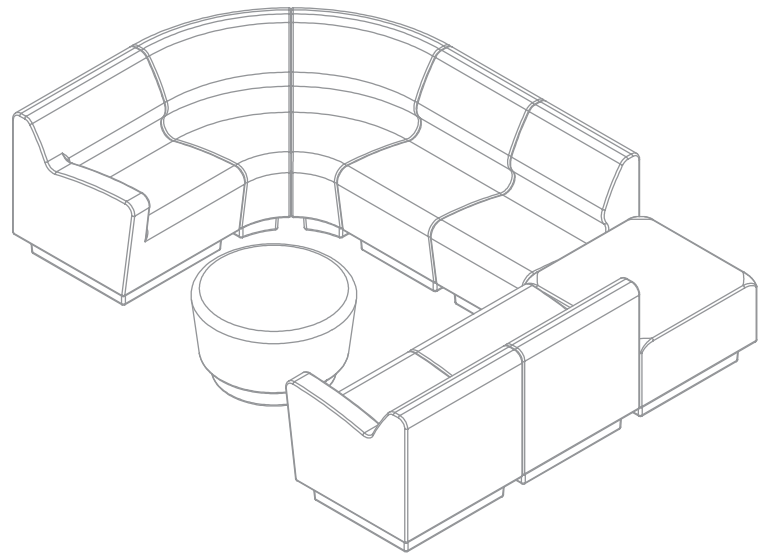

**Seat Colors**

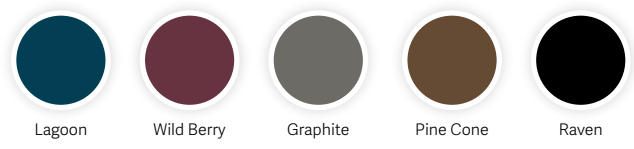

**Molded Wood Grain Legs**

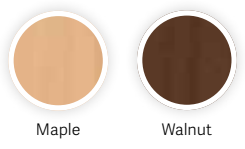

**Molded Base**

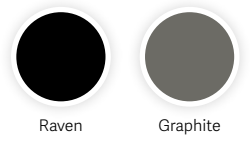

**Steel Base**





# MIX-UP™ SERIES

Mix-Up™ is a furniture line from Norix that allows you to use five different-shaped products to produce endless configurations. This diverse series is perfect for lobbies and any other areas where attractive and durable furniture is applicable. Endless upholstery options and two base colors allow facilities to pick an aesthetic that perfectly matches their environment.

- ✓ ANTI-LIGATURE
  - ✓ TAMPER RESISTANT
  - ✓ CONCEALED STAPLES
- ✓ HEALTHIER HOSPITALS
  - ✓ GREENGUARD GOLD



## Statement of Line



ROUND



LARGE ROUND



WEDGE



RECTANGLE



SQUARE

### Molded Base Colors



Raven



Graphite

### Options

Ballasting  
CAL TB 133 Upholstery



# ROCKSMART®



RockSmart® is a contemporary rocking chair designed from the ground up for soothing comfort, exceptional durability and aesthetic appeal. Its signature one-piece shape is sculpted from rotationally-molded polyethylene for a calming, safe and comfortable rock.

- ✓ TAMPER RESISTANT
- ✓ BLEACH CLEANABLE
- ✓ INFECTION CONTROL
- ✓ GREENGUARD GOLD
- ✓ EXTREME DURABILITY
- ✓ SAFE ROCKING



#### Molded Seat Colors



#### Options

Heavier Weight  
2 Heights  
Available with or without  
floor runner

# SLED BASED

The Safehouse Sled Based Chairs are a collection of real wood seating that is built to last – beautifully. Solid hardwood chairs coordinate with the Safehouse™ desks and table. Available in solid wood seat or upholstered options.

- ✓ TESTED DURABILITY
- ✓ TAMPER RESISTANT
- ✓ HEALTHIER HOSPITALS

## Wood Colors

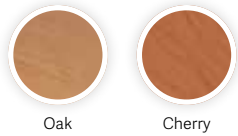

Oak Cherry

## Options

Upholstery  
Arm and Armless



# TOUGH CARE®

The Toughcare® Series chairs are designed and engineered for critical environments and high traffic areas. These chairs are rotationally-molded in one-piece and use high-impact polyethylene with UV stabilizers to reduce fading. Toughcare® chair products can be ganged together, bolted-down or ballasted for added security.

- ✓ INFECTION CONTROL
- ✓ EXTREME DURABILITY
- ✓ HEALTHIER HOSPITALS
- ✓ TAMPER RESISTANT
- ✓ BLEACH CLEANABLE
- ✓ GREENGUARD GOLD



## Statement of Line



ULTRA-MAX  
ARMLESS



ULTRA-MAX  
ARM



SLAMMER  
STOOL



SLAMMER STOOL  
WITH BACK

## Seat Colors



Lagoon Sea Spray Wild Berry River Rock Pine Cone Graphite

## Options

Ganging Kit\*  
Bolt-Down Kit\*  
Ballasting\*  
\*Ultra-Max Arm and Armless Chairs only





# WINK™ SERIES



Modern, colorful, and comfortable, Wink™ has it all. Wink™ will brighten up spaces with its vibrant design and limitless upholstery options. Its playful and curvy construction helps to bring fun to common areas. The one-piece rotationally molded polyethylene frame is impervious to fluids and incredibly impact resistant.

- ✓ CONCEALED STAPLES
- ✓ BALLASTABLE
- ✓ EXTREME DURABILITY
- ✓ NON-REMOVABLE GLIDES
- ✓ TAMPER RESISTANT
- ✓ BLEACH CLEANABLE

#### Seat Colors



#### Options

- Ganging Kit
- Bolt-Down Kit
- Ballasting
- CAL TB 133 upholstery





# TERRA™ SERIES



Terra is a seating series from Norix with a wide assortment of offerings that allow facilities to create highly customized configurations from one product line.

That means no more endless searching for furniture that meets your specific needs. Terra is tailored for one-stop shopping for highly durable and aesthetically pleasing integrated seating.

## Statement of Line



GUEST ARMLESS



2 SEAT TANDEM



3 SEAT TANDEM



## Options

CAL TB 133 Upgradeable Upholstery

- ✓ TAMPER RESISTANT
- ✓ CONCEALED STAPLES
- ✓ NON-REMOVABLE GLIDES
- ✓ GREENGUARD GOLD
- ✓ HEALTHIER HOSPITALS



Seats and backs are constructed with heavy duty wood encased in foam. Hundreds of upholstery options are available in different fabrics, grades and price points, giving facilities the opportunity to match the furniture to their space.

Arm caps are available in wood or polyurethane, while frames are constructed with black or metallic silver steel. Upholstery is double stitched and attached with hidden staples and secure hardware. This assists in keeping products safer and tamper resistant.



Open Arm

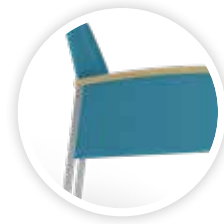

Half Arm

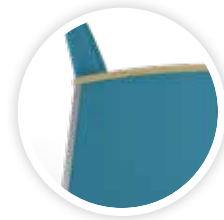

Full Arm

### Frame Colors

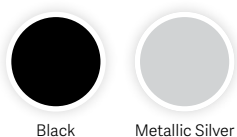

Black

Metallic Silver

### Wood Arm Caps

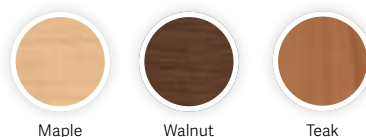

Maple

Walnut

Teak

### Urethane Arm Caps



Black



# FORMA SERIES



Forma, a modular upholstered seating line that is designed with attractive features and engineered to be highly durable. The ten pieces in this designer-friendly line of products – arm chairs, cubes, benches and wedges – are ideal for lobbies, waiting rooms, staff areas and supervised areas such as group therapy and activity spaces.

## Statement of Line



ARM CHAIR



ARMLESS CHAIR



LEFT ARM CHAIR



RIGHT ARM CHAIR



OUTSIDE WEDGE



INSIDE WEDGE



BENCH WEDGE



CUBE



CUBE WITH LAMINATE



CUBE WITH POWER



BENCH



**Options**  
 Bolt-Down Kit  
 Ganging Kit  
 Factory Ballasting (*Plinth Base Only*)  
 CAL TB 133 Upgradeable  
 Upholstery

- ✓ TAMPER RESISTANT
- ✓ NON-REMOVABLE GLIDES
- ✓ GREENGUARD GOLD
- ✓ HEALTHIER HOSPITALS

Facilities can choose from plinth or steel bases, while Norix’s expansive upholstery offerings give customers hundreds of options in different grades, fabrics and price points. Products can be bolted down, ganged or left free-standing, providing facilities maximum flexibility if new configurations are needed in the future or if furniture needs to stay in one place. Forma provides a high level of versatility and can help facilities with all of their furniture needs across their entire environment.

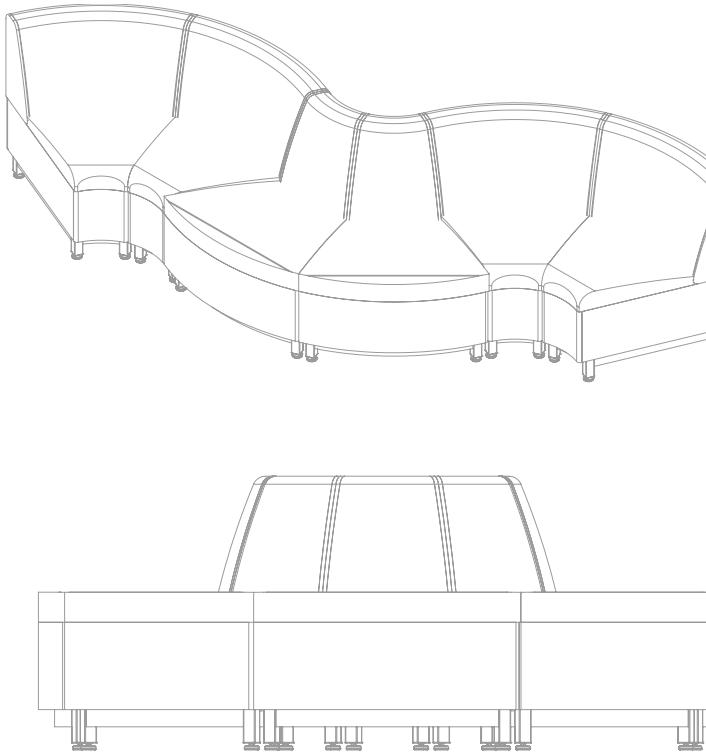

Molded Base

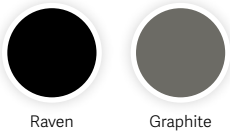

Steel Base



Laminate Tops

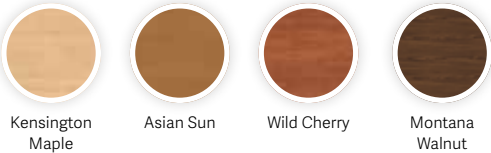



# VESTA™ SERIES



The Vesta™ seating line excels in behavioral healthcare environments due to its robust and minimalist design. The sweeping form fully contacts the floor removing contraband concealment areas and ligature points. Modern style, combined with carefully studied color options, can help elevate any space.

## Statement of Line



GUEST ARMLESS



GUEST ARMLESS  
UPHOLSTERED



GUEST ARM



GUEST ARM  
UPHOLSTERED



LOUNGE ARMLESS



LOUNGE ARMLESS  
UPHOLSTERED



LOUNGE ARM



LOUNGE ARM  
UPHOLSTERED





**Options**

Arm and Armless  
 Bolt-Down Plate  
 Ballasting  
 Optional upholstery  
 CAL TB 133 upholstery available

- ✓ INFECTION CONTROL
- ✓ ANTI-LIGATURE
- ✓ BLEACH CLEANABLE
- ✓ EXTREME DURABILITY
- ✓ GREENGUARD GOLD
- ✓ HEALTHIER HOSPITALS

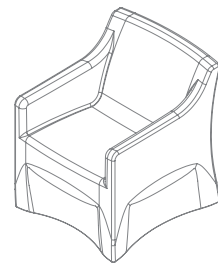
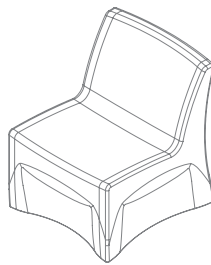
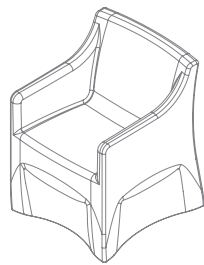
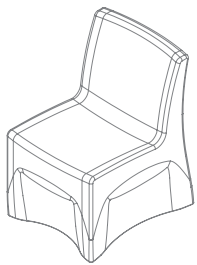

Vesta's attractive residential appearance is an appropriate complement to any interior environment.

Vesta™ is available in several colors and hundreds of upholstery options.

Cushioning is stitched and attached with hidden staples and secure hardware to assist in keeping products safe and tamper-resistant.



**Seat Colors**

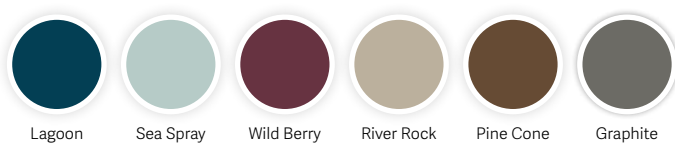

Lagoon    Sea Spray    Wild Berry    River Rock    Pine Cone    Graphite



# FORTÉ® CAFÉ



## General Dimensions



Molded cylindrical hour glass base pairs with Vesta™ or Forté® Guest Chairs. Available as a one-piece polymer table or with optional laminated top options. Engineered and proven suitable for daily use in behavioral environments.

- ✓ TAMPER RESISTANT
- ✓ EXTREME DURABILITY
- ✓ ROUNDED EDGE
- ✓ HIGHLY CLEANABLE
- ✓ BALLASTABLE
- ✓ GREENGUARD GOLD

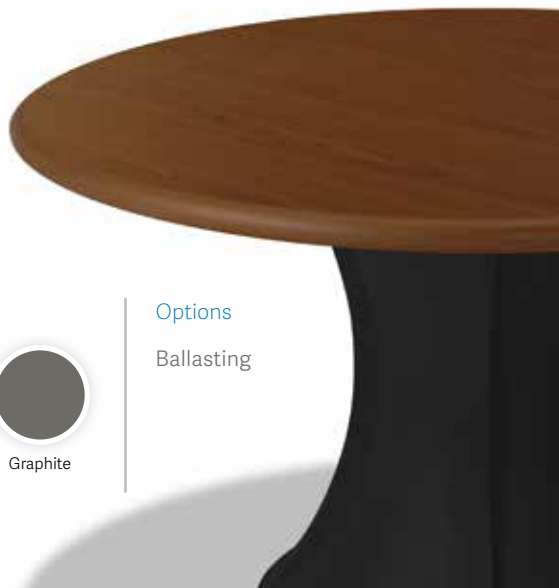

### Laminate Tops

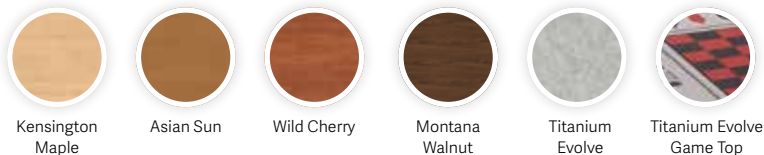

### Base Color

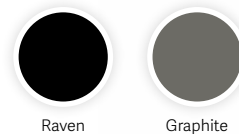

### Options

Ballasting



# X-BASE

Years ago, we were challenged to design a table that defined each person's space. Our answer was the popular, rugged X-Base Table with its unique "X" base design. Today, the X-Base Table is used in a variety of facilities all across the country.

**General Dimensions**

36" 42" 48"

36" 42"



- ✓ SECURE MOLDED EDGE
- ✓ STEEL-TO-STEEL CONNECTION
- ✓ GREENGUARD GOLD
- ✓ ROUNDED EDGES
- ✓ EXTREME DURABILITY

**Laminate Tops**

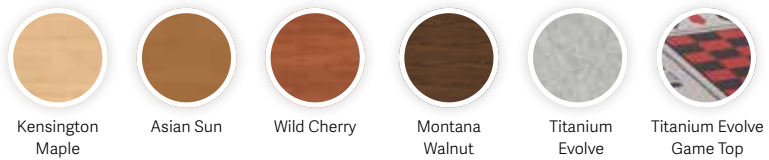

**Base Color**

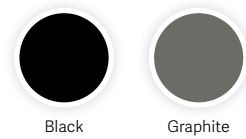

**Options**

1 1/4" thick laminate top with black vinyl T-mold edge

# JUPITER

Sometimes you want a table that is easy to move around. Other times you'd like that table to stay in one place, but you don't want to bolt it to the floor. Enter the Norix® Jupiter Table! Jupiter is designed to be weighted on site to maintain space flexibility and allow for efficient floor maintenance as the needs of an environment change.

**General Dimensions**

36" 42" 48"

36" 42"



- ✓ TAMPER RESISTANT
- ✓ ROUNDED EDGES
- ✓ HIGHLY CLEANABLE
- ✓ EXTREME DURABILITY
- ✓ BALLASTABLE
- ✓ GREENGUARD GOLD

**Laminate Tops**

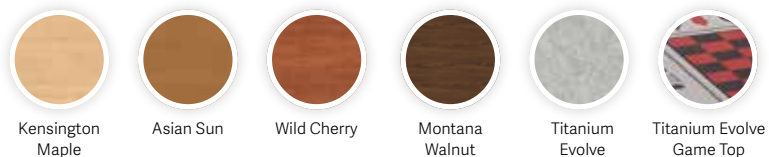

**Base Color**

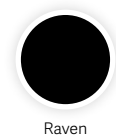

**Options**

Ballasting



# OASIS® SERIES



If your environment demands a more robust solution for cluster seating, your search is over. The Oasis® Series is designed and engineered specifically for dining halls and is perfect for situations where users need more back support than traditional stools provide.

- ✓ MOLDED EDGE
  - ✓ INFECTION CONTROL
  - ✓ EXTREME DURABILITY
- ✓ BLEACH CLEANABLE
  - ✓ HEALTHIER HOSPITALS
  - ✓ GREENGUARD GOLD

## General Dimensions

30"x48"

30"x72"

## Seat Colors



Lagoon

Sea Spray

Wild Berry

River Rock

Pine Cone

Graphite

## Top Finishes

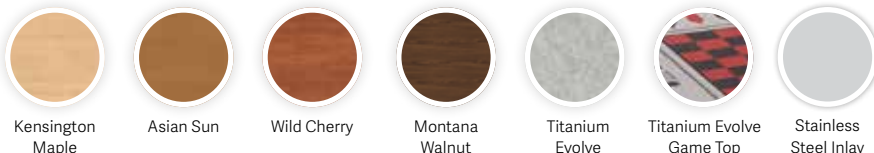

Kensington Maple

Asian Sun

Wild Cherry

Montana Walnut

Titanium Evolve

Titanium Evolve Game Top

Stainless Steel Inlay

## Frame Colors



Metallic Silver

Black

## Options

- ADA
- Glides
- Bolt-Down
- Fixed Seats
- Swivel Seats

# LEG STYLE

When you start with 4" diameter 14 gauge tubular steel legs fully welded to 1/4" steel mounting plates, you end up with an incredibly strong, stable and durable table. The legs are joined to the top using tamper-resistant screws connected to embedded T-nuts, for a secure steel-to-steel connection. Optional 2 1/2" legs provide an attractive residential alternative.

- ✓ SECURE MOLDED EDGE
- ✓ STEEL-TO-STEEL CONNECTION
- ✓ HEALTHIER HOSPITALS
- ✓ ROUNDED EDGES
- ✓ EXTREME DURABILITY
- ✓ GREENGUARD GOLD

## Laminate Tops

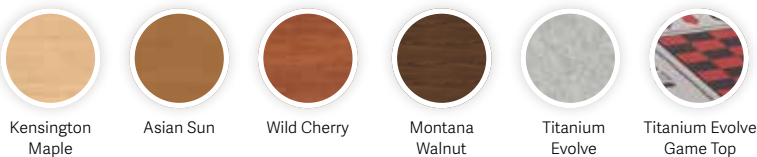

## Leg Color

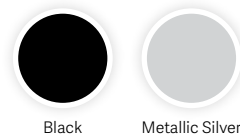

## Options

2" or 4" Legs  
Bolt-Down Configuration

**General Dimensions**

36"

42"

48"

30"x72"

30"x96"



# TABLA

Tabla is a laminated table solution that can add residential touches to lobbies, common areas and any other space that requires aesthetically pleasing and highly durable furniture products. Available in two different sizes, facilities can choose from different laminates that can humanize environments that may otherwise be institutional in nature.

- ✓ TAMPER RESISTANT
- ✓ STEEL-TO-STEEL CONNECTION
- ✓ HIGHLY CLEANABLE
- ✓ GREENGUARD GOLD
- ✓ HEALTHIER HOSPITALS

## Laminate Tops

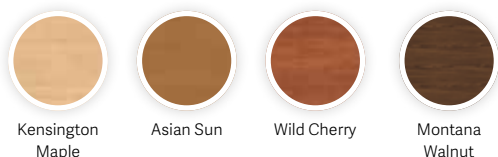

## Premium Base Color



**General Dimensions**

18"

36"





# MAX-MASTER SERIES



Engineered for superior strength and durability, the Max-Master Series is particularly well suited for dining halls and dayrooms where reliable performance is a must. Whether bolted to the floor or freestanding on adjustable glides, the distinctive individual seat/leg design provides superior stability than traditional pedestal tables. Compression molded composite seats, premium table top and unique steel leg design delivers an exceptional table for continuous daily use in challenging environments.

## Statement of Line



4 SEAT  
ROUND



6 SEAT  
RECTANGLE



6 SEAT  
ROUND



8 SEAT  
RECTANGLE



8 SEAT  
ROUND





### Options

Leg Protectors, Stainless Steel Seats, Non-Removable Glides, Bolt-Down

- ✓ ROUNDED EDGES
- ✓ TAMPER RESISTANT
- ✓ EXTREME DURABILITY
- ✓ HIGHLY CLEANABLE
- ✓ HEALTHIER HOSPITALS
- ✓ GREENGUARD GOLD

Our unique leg design is the key to the form and a function of this high-performance fixed seating. The curved section is fully welded to a vertical seat support and both the seat supports and top supports have 6"x 6"x 1/4" thick steel mounting plates welded on. When you consider that the tube is 3" diameter 14 gauge steel, you understand that we're talking serious structure here.

### General Dimensions

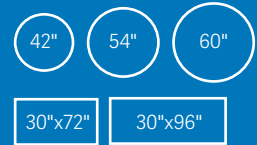

### Seat Colors

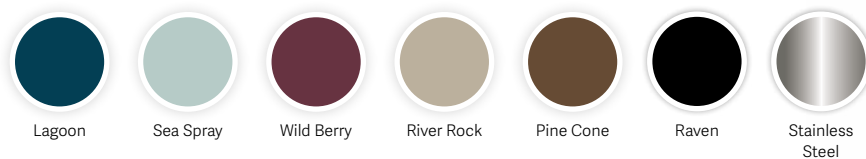

### Top Finishes \*Available in select styles: Game Top, Stainless Steel Channel and Stainless Steel with Quietcore.

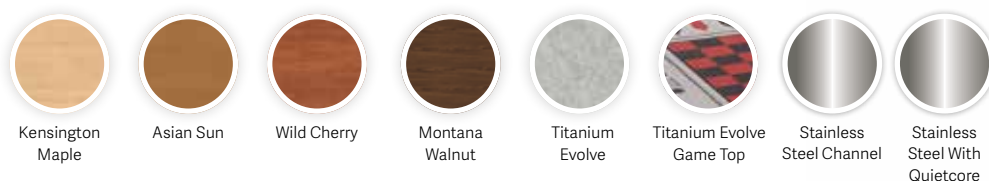

### Frame Colors





# FORTÉ<sup>®</sup> OCCASIONAL

Freestanding occasional tables can be optionally ganged with lounge seating for intermediate or end tables. Choose one of three base options – wood, steel or molded polymer – and pair with your choice of molded polymer or laminate top with permanently affixed urethane edge. All tops come with embedded T-nuts for a secure steel-to-steel connection.

- ✓ ROUNDED EDGES
- ✓ TAMPER RESISTANT
- ✓ EXTREME DURABILITY
- ✓ HIGHLY CLEANABLE
- ✓ HEALTHIER HOSPITALS
- ✓ GREENGUARD GOLD



## Base Options

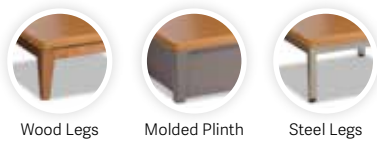

Wood Legs    Molded Plinth    Steel Legs

## Wood Legs

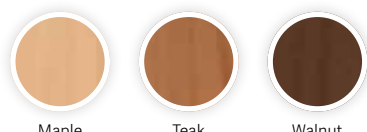

Maple    Teak    Walnut

## Molded Base



Raven    Graphite

## Steel Base



Metallic Silver

## Molded Top Colors



Lagoon    Sea Spray    Wild Berry    River Rock    Pine Cone    Graphite

## Laminate Tops



Kensington Maple    Asian Sun    Wild Cherry    Montana Walnut    Titanium Evolve

## Options

Ganging  
Bolt-down  
Ballasting\*  
\*Molded Base Only



# MULTI-PURPOSE

Most commercial tables are put together with easily removed screws, nuts, bolts, screw-out glides and snap-on parts. Norix created the Multi-Purpose Series of tables specifically to avoid those attributes so you don't have to think about the possibility of injury by altered furniture parts.



- ✓ CONTRABAND RESISTANT
- ✓ HEALTHIER HOSPITALS
- ✓ TAMPER RESISTANT
- ✓ TORX SECURITY HARDWARE
- ✓ STEEL-TO-STEEL CONNECTION
- ✓ HIGHLY CLEANABLE



## Laminate Tops

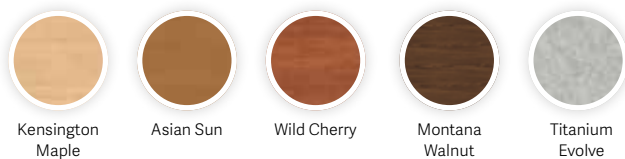

## Leg Color



## General Dimensions







# KUBE SERIES



Kube is the modern table and chair collection designed to be grouped, moved, and used to optimize any space. Hundreds of configurations are possible, combining the table, bench, arm & armless, and corner Kube pieces.

## Statement of Line



ARMLESS  
CHAIR



LEFT ARM  
CHAIR



RIGHT ARM  
CHAIR



CORNER  
CHAIR



BENCH



TABLE





**Options**  
 Bolt-Down  
 Ganging Kit  
 Ballasting  
 Upgradeable to TB 133 Uphol-  
 stery





- ✓ TAMPER RESISTANT
- ✓ BLEACH CLEANABLE
- ✓ EXTREME DURABILITY
- ✓ ROUNDED EDGES
- ✓ GREENGUARD GOLD

Kube is a one-piece rotationally molded design that creates safe, supervised areas and provides for long-term ROI. The easy-to-clean exterior withstands bleach cleaners, the legs feature removable glides, and each piece can be ganged together, ballasted, or bolted down.

Configure your Kube setup with multiple colors, configurations, and fabric options to create the perfect modern space in your facility.



**Base Colors**

-   
Cobalt
-   
Malibu
-   
Graphite
-   
Grey Velvet

**Options**

- Bolt-down
- Ganging Kit
- Factory Ballasting



# RIPTIDE® SERIES

The organic flow of our ocean waters is the inspiration behind the latest addition to Norix Outdoors, the Riptide Bench. Riptide is a fun and inspiring seating solution. This curvy piece is anything but ordinary and livens up spaces for inspiring creativity or providing some much-needed rest and relaxation. This modular bench seat is a stand-alone piece or can be ganged together with the Riptide Wishbone for even more thought-provoking and refreshing outdoor spaces.

- ✓ INFECTION CONTROL
- ✓ BLEACH CLEANABLE
- ✓ EXTREME DURABILITY
- ✓ ROUNDED EDGES
- ✓ GREENGUARD GOLD
- ✓ HEALTHIER HOSPITALS

#### Options

Ganging plates  
Anchor kit  
On site Ballasting

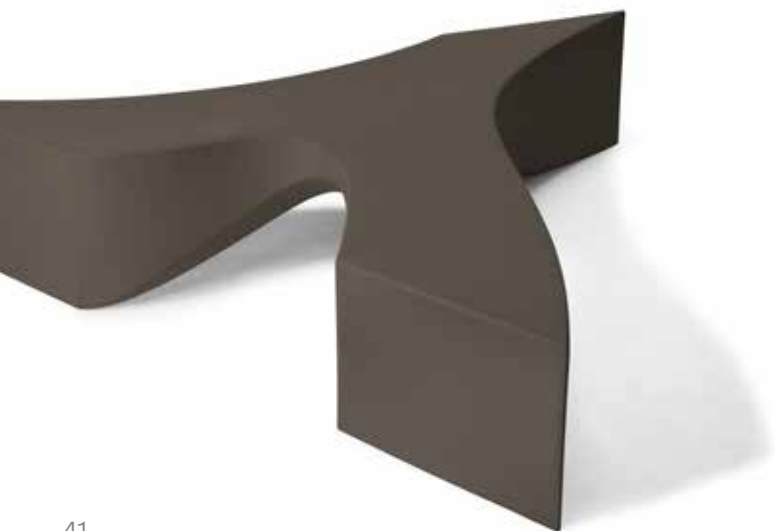





# GOBY® SERIES

Safely utilize your outdoor spaces with Norix outdoors. Recent shifts in how we think about the benefits of open-air environments have shifted administrators to consider how they can take advantage of nature for mental health and well-being. As a result, Norix researchers have developed a modern outdoor furniture collection.

- ✓ INFECTION CONTROL
- ✓ BLEACH CLEANABLE
- ✓ EXTREME DURABILITY
- ✓ ROUNDED EDGES
- ✓ GREENGUARD GOLD
- ✓ HEALTHIER HOSPITALS

## Seat Colors



Cobalt



Malibu



Graphite



Grey Velvet

## Options

Bolt-down plates  
On site Ballasting

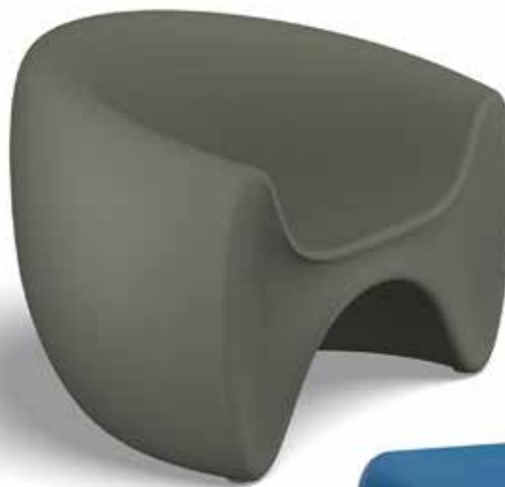



# A-MAZE™ SERIES



A kids furniture product from Norix, A-Maze™, is a one-seat wonder due to the endless configurations that can be created. Its four colors, secure construction and playful shape make this perfect for play areas or any other place where children may gather. This light-weight product can be moved and reconfigured as needed and is applicable to high-traffic and constant-use areas.

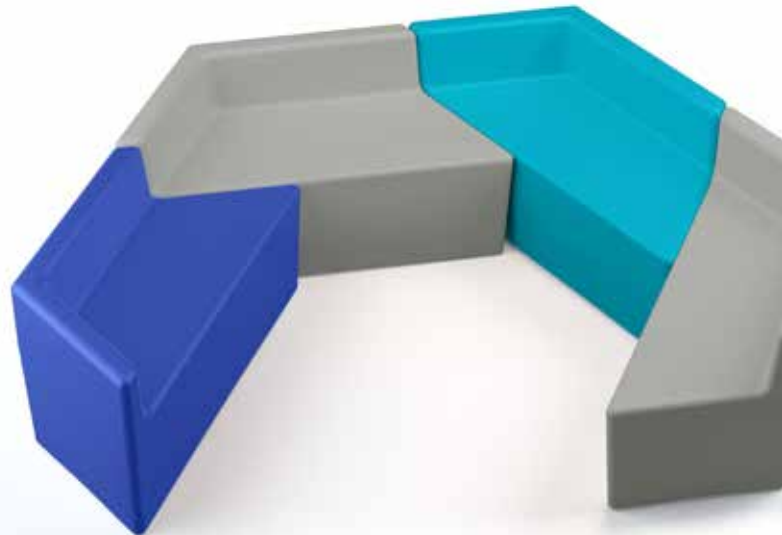
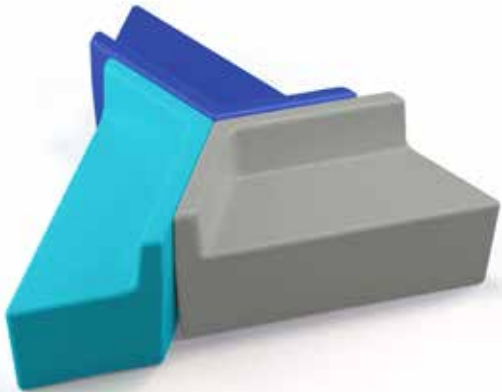





# ELLE SERIES



The Elle Series Chair and Table is a fairy-tale take on kids furniture for facilities looking for a seating solution that is fun and safe for use by children. Both Elle products are available in four colors and are highly durable.

- ✓ INFECTION CONTROL
- ✓ EXTREMELY DURABLE
- ✓ ROUNDED EDGES
- ✓ HEALTHIER HOSPITALS
- ✓ BLEACH CLEANABLE
- ✓ GREENGUARD GOLD



## Colors



Cobalt



Malibu



Habanero



Grey Velvet





# HEX-IT SERIES



Oh Hex! No, we aren't commanding you to put a spell on it. The name Hex-It actually is derived from the hexagonal shape of this kids seating and table solution from Norix®. This multi-function marvel allows you to flip the product on one side and use it as a stool. Flip it on its other side and you have a table. It's an ideal kids seating solution with a fun shape that's ready to be configured to your space.

- ✓ INFECTION CONTROL
- ✓ EXTREMELY DURABLE
- ✓ ROUNDED EDGES
- ✓ HEALTHIER HOSPITALS
- ✓ BLEACH CLEANABLE
- ✓ GREENGUARD GOLD

## Colors



Cobalt



Malibu



Habanero



Grey Velvet





# DURAVISION™



DuraVision™ polycarbonate mirrors from Norix® are designed specifically for challenging environments. The strength of polycarbonate combined with a solid, full foam backing and a unique steel frame design ensures superior long term durability.

- ✓ ANTI-LIGATURE
- ✓ EXTREMELY DURABLE
- ✓ TAMPER RESISTANT
- ✓ GREENGUARD GOLD

## Statement of Line



FULL DOME



HALF DOME



QUARTER DOME



WALL ROUND



WALL RECTANGLE

Frame

Mirror



Cream



Silver



# ACCESSORIES/ WASHROOM

Safety is the issue and Norix has the solution. All accessories are easy-to-clean stainless steel.



## Recessed Shelf

No sharp corners or edges protruding from the wall to inflict injury. The chase-mounted recessed shelf comes in easy-to-clean stainless steel.



## Toilet Paper Holder

Front mount toilet paper holder is available in easy-to-clean stainless steel.



## Towel Hooks

Holds towels or clothing articles safely without the use of protruding pegs or hooks. The surface mounted towel hooks come in stainless steel. Choose from single towel hooks or groups of four.



## Ball Clothes Hooks

Single collapsible safety hooks or groups of four with optional 8" deep X 18" long bookshelf. Ball and stem style in stainless only.



## ADA Shower Seat

Stainless steel detention-grade recessed shower seat. ADA version meets ADA 4.21.3 & 4.26.3 requirements for L-Shaped Shower Seats.



## Wall Mirror

One-piece #430 stainless steel. Highly polished #8 finish. Two standard sizes: 9 1/2" x 11 1/4" and 11 1/4" x 17 1/4". Mount direct to wall or with an optional 1/4" thick steel backer plate. Optional embed plate also available. ADA size mirror option available at 11 1/4" x 38".



# ADA FURNITURE

## ADA Oasis™ Cafeteria Table

Sturdy, healthcare grade tables with fixed seating. Laminate top with molded radiused edge.



## Prodigy® Desk

Classic table desk with modesty panel. Attractive inset panel design allows for placement flush against wall or in corners. ADA compliant.

## Attenda® Desk

Laminate top with molded radiused edge. Mounts securely to floor. ADA compliant.



## ADA Shower Seat

Healthcare grade, recessed ADA compliant shower seat. Easy-to-clean stainless steel finish.



## Norix Installation Services

Norix education furniture is safe, secure and built to last ...providing outstanding long-term value and peace of mind for your staff. For facilities not using contractors or consultants, it makes sense to reinforce the benefits of the furniture with a installation from Norix.

### Benefits of Installation Services:

- Expert installation services, performed by professionals experienced in all facility installations.
- Complex installation capabilities, including field drilling into concrete, secure bolt-down and application of security caulk.
- All labor, installation hardware and materials included.
- Seamless transaction on same purchase order as furniture.
- Reinforces product warranty.





**AT NORIX, WE DESIGN INNOVATIVE,  
ROBUST FURNITURE THAT MEETS THE  
REAL-WORLD NEED FOR HUMANIZING  
CHALLENGING ENVIRONMENTS.**

Norix is not just a corporation, we're a family. We care about the people we serve, our community and our team.

We create contemporary designs that humanize our industry without sacrificing robust structural integrity.

Our products are built with the wellbeing of the people who use the furniture in mind, as well as the people around them.

**[NORIX.COM](https://www.norix.com)**

AT NORIX, WE DESIGN INNOVATIVE, ROBUST FURNITURE THAT MEETS THE REAL-WORLD NEED FOR HUMANIZING CHALLENGING ENVIRONMENTS.

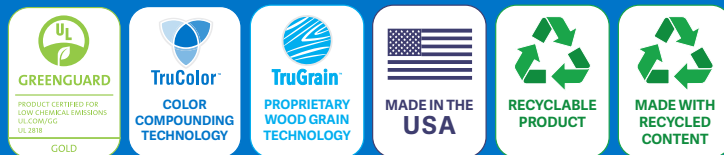

Individual attributes vary by product. See specification sheet for details

**NORIX**<sup>®</sup>  
BEHAVIORAL HEALTHCARE

One Innovation Drive, West Chicago, Illinois 60185  
Phone: 630-231-1331 | Toll Free: 800-234-4900 | Fax: 630-231-4343  
2/22 | furniture@norix.com ©2022 Norix Group, Inc.

**NORIX.COM**