

BEHAVIORAL HEALTHCARE

2 0 2 1



ENGINEERED TO ENDURE[®]

Norix Behavioral Healthcare Furniture

Norix is a leading provider of behavioral healthcare furniture solutions that are specially designed for facilities looking to create safe and secure environments. Designed and engineered specifically for critical applications, Norix psychiatric furniture is ideally suited for facilities unwilling to compromise on safety or humanizing aesthetics in pursuit of a therapeutic environment.

Our unique mental healthcare furniture includes anti-ligature products designed after consultation with field-experienced practitioners who are well-versed in safety requirements for patients and staff. Our durable furniture products are easy to clean, tamper-resistant and resilient to cleaning agents and fluids.

Select from a variety of special needs furniture including behavioral healthcare tables, beds and seating to suit your requirements for safety, security and the creation of a therapeutic and humanizing environment.

Table of Contents

1

Group / Dayroom

21

Dining

29

Lobby / Waiting

37

Patient Room

47

Geriatric

49

Activity Room

52

Bath

55

High Security Mirrors / ADA

57

Installation Services



NEW!



ANTI-LIGATURE

Careful flush to the floor design avoids tie offs.

TAMPER RESISTANT

One-piece security conscious design for greater safety.

UNMATCHED CLEANABILITY

Non-absorbent polymer for greater infection control.

Prodigy Bedroom Warmth of Wood, Performance of Polymer

Prodigy features the latest Norix innovations in an uncompromising line of high performing and aesthetically pleasing bedroom furniture. It is designed and engineered to overcome the daunting challenge of creating a humanized environment without sacrificing safety, security and long term performance. Prodigy is at the vanguard of innovation and advances the Norix legacy of spearheading breakthroughs in behavioral healthcare. Patent Pending.

Crafted in a specially forged polymer with proprietary innovations to deliver superior durability, maintenance free cleanability and humanizing aesthetic appeal. Each piece is uniquely fashioned with specialized TruGrain polymer to replicate natural wood and deliver a residential, non-institutional appearance.

Colors



Harvest



Java

Therapeutically Attractive

Attractive wood grain appearance to enhance the calming familiarity of a home-like environment.

Designed for Safety

Superior to wood in infection-control and ligature, fluid, tamper, infestation and contraband resistance. Concealed anchoring.

Durable

Structurally reinforced for superior durability, impact resistance and security.

Maintenance-Free

Seamless one-piece construction delivers unmatched cleanability and long-term, maintenance-free performance.

Environmentally Responsible

Recyclable polymer is made responsibly with recycled content.



Proprietary TruGrain™ aesthetic provides authentic texture and gradation that replicates natural wood. Each piece is uniquely fashioned to deliver a residential, non-institutional appearance. Special polymer delivers superior durability, maintenance-free cleanability, and humanizing aesthetic appeal. Patent Pending.



EXTREMELY DURABLE
Impact resistant and tested to 1,500 lbs. static load.

TRUGRAIN™ TECHNOLOGY
Warmth of wood, performance of polymer.

CONTRABAND RESISTANT
Residential inset panel allows for flush wall mounting.

CONCEALED HARDWARE
For secure and attractive floor anchoring.



Panel Bed

Anti-ligature bed with inset panel design aesthetic creates a “classic” residential look yet allows placement flush against wall or in corners. Raised lip on bed deck with grooved sleep surface for fluid management. Select free-standing version with fully closed bottom or floor-anchor model (all anchoring hardware included.) Optional restraint rings.



Nightstand

The Prodigy Nightstand is the perfect complement to the Panel Bed. Smaller top cubby keeps essentials within easy reach; bottom cubby holds larger items. Includes all anchoring hardware for floor mounting and non-removable floor guide kit for a free-standing alternative.



Open Chest

Ideal anti-ligature solution - storage for larger items with no doors, drawers or hinges. Includes all anchoring hardware for floor mounting and non-removable floor guide kit for a free-standing alternative.



Desk

Classic table desk with modesty panel. Attractive inset panel design allows for placement flush against wall or in corners.



Vesta Seating

One curvy design with tons of upholstery options

The Vesta chair collection provides a unique blend of ultra-safe design with beautiful curved surfaces and colors. The sweeping form is designed to fully contact the floor to mitigate ligature points and can be ballasted for extra security. The rotationally-molded polyethylene is easy to sanitize and provides superior durability.

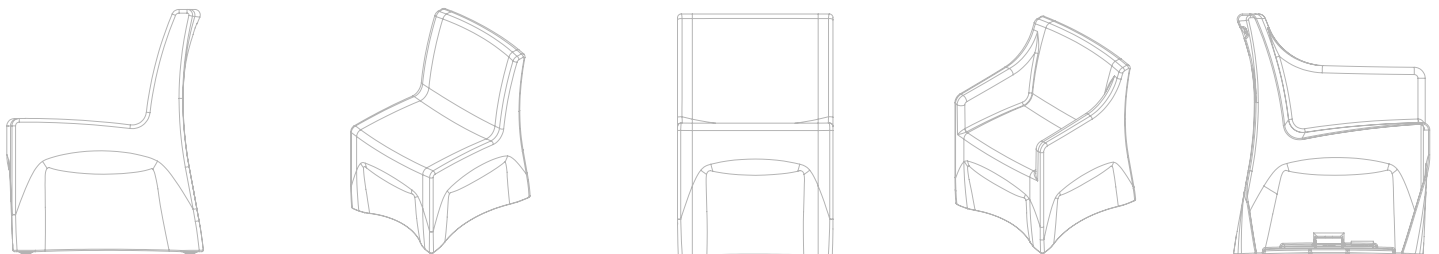
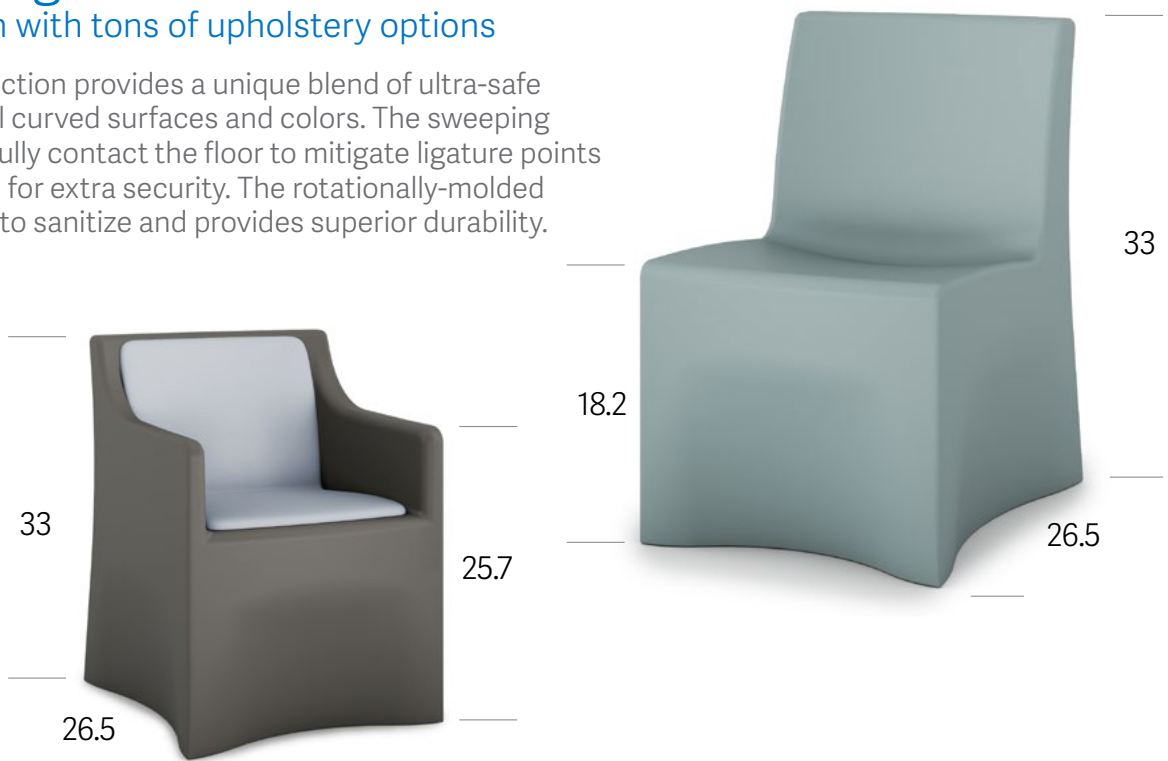

Anti-Ligature Design

Full Contact from Base to Floor

Vesta's attractive residential appearance is an effective resource for creating a comforting therapeutic environment. Vesta is available in several colors and hundreds of upholstery options. Cushioning is attached with hidden staples and secure hardware to assist in keeping products safe and tamper-resistant.

Cushions attached with hidden staples to avoid tampering

Hundreds of upholstery options.

Rotationally-molded for durability and optimum cleanability

Available in 9 colors

Non-removable steel encased nylon glides for floor protection.

Safe secure ballasting with underside threaded screw cap.

Anti-Ligature designed for full contact to the floor around the entire base.



Seat Color



Options: CAL TB 133 Upgradeable Upholstery

Testing: GREENGUARD and GREENGUARD Gold Certified, California Technical Bulletin 133, UL 2818. UL.COM/GG, BIFMA 5.4 15.4.2, ANSI/BIFMA X5.4-2012, 750 static load



Terra Seating Series

Terra is a seating series from Norix with a wide assortment of offerings that allow facilities to create highly customized configurations from one product line. That means no more endless searching for furniture that meets your specific needs. Terra is tailored for one-stop shopping for highly durable and aesthetically pleasing integrated seating.

Frame Colors



Black



Metallic Silver

Wood Arm Caps



Maple



Walnut



Teak

Urethane Arm Caps



Black



26.4

25.5

22" seat width

30" seat width

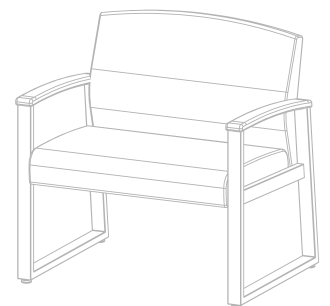
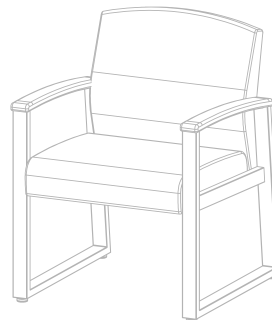

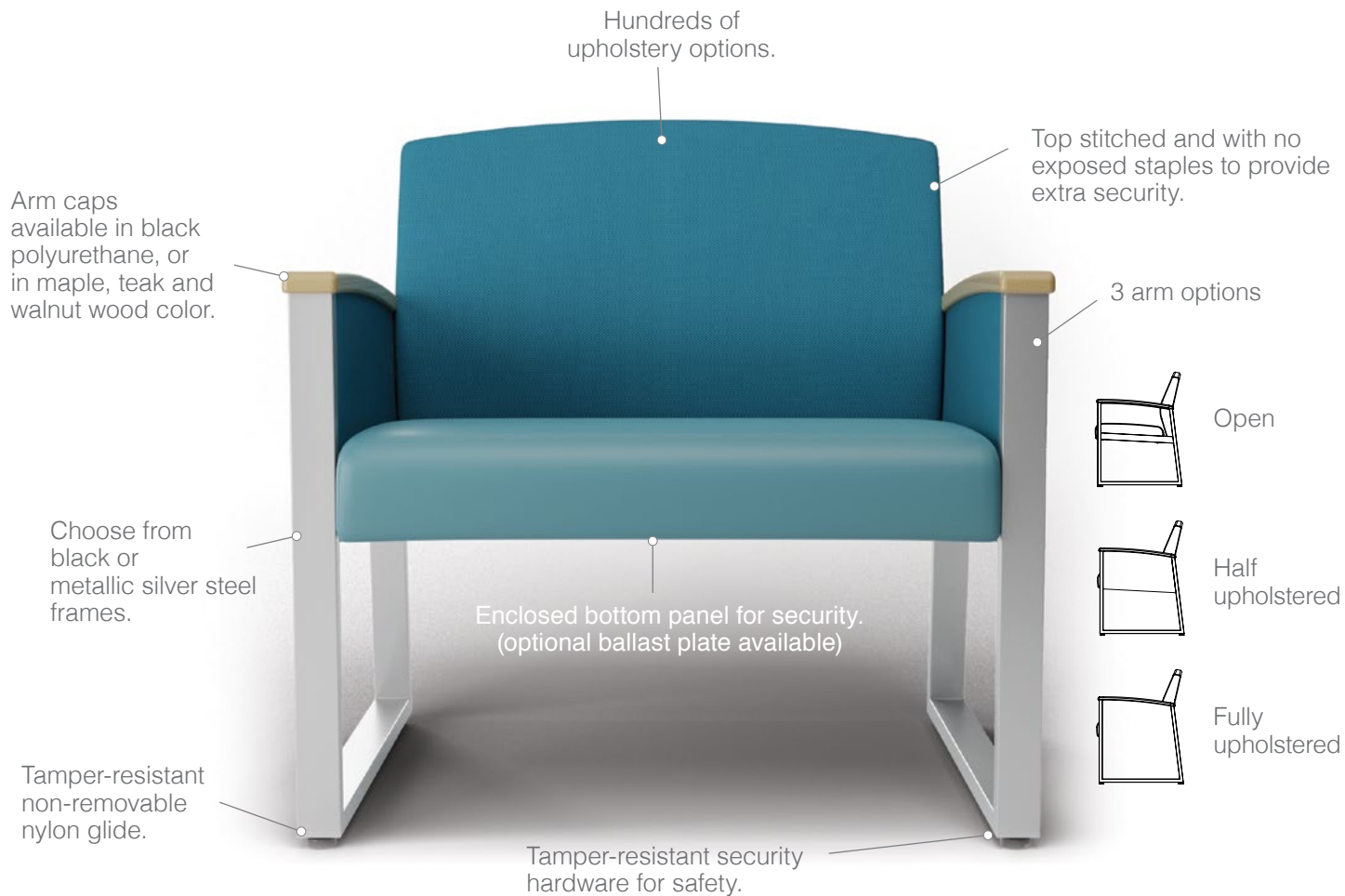

Tons of Seating Options

Seats and backs are constructed with heavy duty wood encased in foam. Hundreds of upholstery options are available in different fabrics, grades and price points, giving facilities the opportunity to match the furniture to their space.

Arm caps are available in wood or polyurethane, while frames are constructed with black or metallic silver steel. Upholstery is top stitched and attached with hidden staples, and secure hardware means products are safer and tamper-resistant.



Options: CAL TB 133 Upgradeable Upholstery

Testing: GREENGUARD and GREENGUARD Gold Certified, UL 2818. UL.COM/GG, BIFMA 5.4 15.4.2, ANSI/BIFMA X5.4-2012, 750 lb static load



Affinty Seating

Affinity. A natural liking for, or attraction to a person, idea, or thing. That thing from Norix is a chair, but not just any chair. Affinity represents the great length Norix engineers have gone to create a chair that blends attractive form, comfort, versatility, and reliability.

Affinity combines a metallic silver frame with hundreds of seat and back options. Available with or without arms, and optional upholstered or wood back, the chair makes a great companion to the broad assortment of Norix tables. Contrasting fabrics are available for an even more dynamic look.

The elegant appearance of Affinity lends itself extremely well to lobbies, meeting spaces, and dining areas.

Wood Back Color Options



Walnut (Stain)



Maple



Black

Urethane Arm Caps

Frame



Steel



Formed Arch and Waterfall Curves.

The contoured shapes of Affinity promote a highly comfortable sitting experience.

Affinity embodies the assumed quality that separates Norix from other furniture providers. Features include hex bolt hardware, durable polyurethane arm caps, and nylon guides to help protect floor surfaces. Fully welded frame connection points provide a reliable foundation. Double-stitched cushions with hidden staples are field-replaceable to allow for easy maintenance and longevity.

Optional upholstered or wood backs. Wood backs available in either Maple (shown) or Walnut color.



Options: CAL TB 133 Upgradeable Upholstery

Testing: GREENGUARD and GREENGUARD Gold Certified, UL 2818. UL.COM/GG, ANSI/BIFMA X5.4-2012, 500 lb static load



Harmony™ Seating

The Harmony Series blends form and function to deliver the unique combination of exceptional durability and a residential look for facilities that need humanizing products for their challenging environments. Limited lifetime warranty for structural integrity. In spite of that rugged interior, the Harmony Series is elegant, versatile and aesthetically pleasing.



Arm Cap/Feet



Black



Arm Chair

Square Back Round Back



Love Seat

Square Back Round Back



Sofa

Square Back Round Back



Bariatric Chair



Armless



High Back Chair



2 Seat Bench

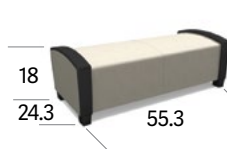

3 Seat Bench

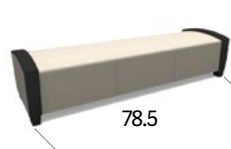

Coffee Table

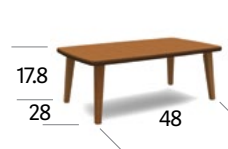

End Table

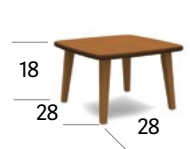

Superior Construction

Weighing in at 130 lbs, Harmony's interior steel frame is built for unparalleled structural integrity. Love seats, sofas, and benches offer the same construction with more seating options.



High Back Chair

The high back chairs offer comfortable and supportive seating for geriatric populations and patients who may be immobilized or medicated.



Options: CAL TB 133 Upgradeable Upholstery

Testing: GREENGUARD and GREENGUARD Gold Certified, UL 2818. UL.COM/GG, ANSI/BIFMA X5.4-2012, BIFMA 5.4 15.4.2, 1000 lb Static Load

Element™

Element is a designer-friendly series of lounge furniture that provides facilities with maximum versatility. Mix and match the Element Lounge Chair, Love Seat and Sofa throughout your facility depending upon the needs of spaces.

Durability

Element is highly durable due to construction and the materials. On the inside, Element is supported by a sturdy milled-wood frame that is connected with metal hardware to ensure durability and longevity. On the outside, the arm rests are protected and covered with a specially formulated, pick and pry resistant arm cap. These arm caps are available in black and are mounted to the wood frame with steel T-nuts.



Specially formulated, pick and pry resistant arm cap attached to frame with T-nuts.

Clean out between seat and back allows dirt and debris to fall to the ground rather than gather in chair.

Upholstery available in a variety of patterns and grades.

Frame is made of heavy duty milled wood for strength and durability.

Injection-molded nylon feet are engineered for strength and to protect floors.

Generous seat width and cushioned support provide comfortable lounging.



Lounge Chair



Love Seat



Sofa



Arm Cap/Feet



Black

Options: CAL TB 133 Upgradeable Upholstery

Testing: GREENGUARD and GREENGUARD Gold Certified, ANSI/BIFMA X5.4-2012, UL.COM/GG, BIFMA 5.4 15.4.2, 1000 lb Static Load





RockSmart™

RockSmart is a contemporary rocking chair designed from the ground up for soothing comfort, exceptional durability and aesthetic appeal. Its signature one-piece shape is sculpted from rotationally-molded polyethylene for a calming, safe and comfortable rock. The 18" is slightly taller, wider, and deeper. Both have a heavier formulation should your facility need a more secure ballasted rocker. Available in two sizes and weights to fit your needs.

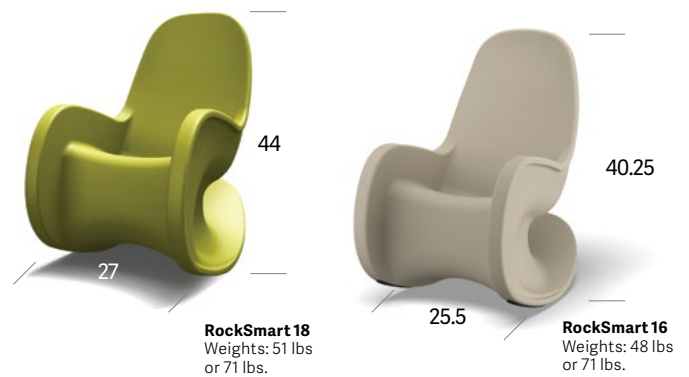

TruColor™ Premium material is fully compounded for superior color and quality assurance.

No assembly required.

Engineered to Endure. Dynamic drop tested to a relative impact force of two times BIFMA 5.4 15.4.2 and 500 lb static load while also CAL TB133 compliant.

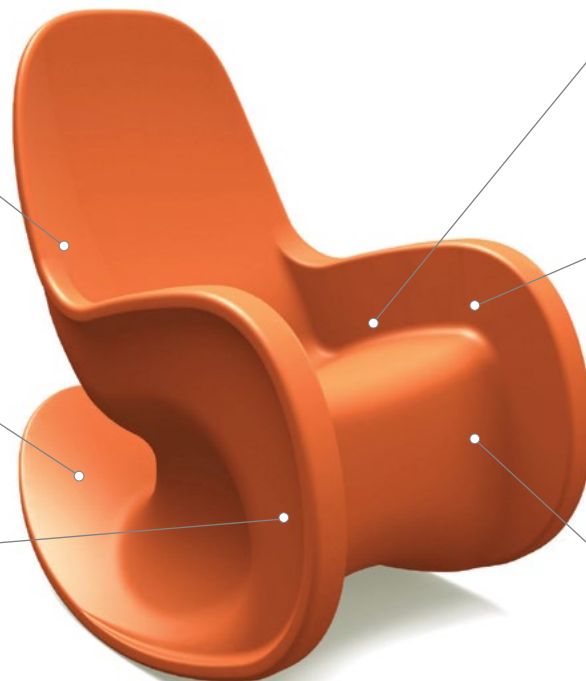

Sculpted shape provides an ergonomically comfortable sit.

The original rocking chair for Behavioral Healthcare facilities.

One-piece rotationally-molded polyethylene with lightly textured surface allows for easy cleaning.

Seat Color



Testing: GREENGUARD Gold Certified, California Technical Bulletin 133 UL1056, ASTM E1537, NFPA 261, UL94 HB, British Standard BS 7176: 2007, 500 lb Static Load



Forté® Lounge

Forté® is the designer series of furniture that is fashioned for comfort, flexibility and durability. With a variety of colors to choose from and an upholstery option for seating, this series is made to humanize behavioral health environments and includes a lounge chair and guest chair that come with or without arms. These products are engineered and proven suitable for daily use in demanding environments.

Wood Base



Maple



Walnut



Teak

Molded Base

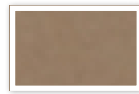

Fossil

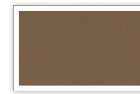

Moss

Steel Base



Metallic Silver

Extremely durable, one-piece rotationally-molded polyethylene seat is impervious to fluids and incredibly impact resistant.

Molded-in steel threaded inserts provide secure steel to steel connections and optional ganging side-to-side.

Dynamic drop tested to a relative impact force of two times BIFMA 5.4 15.4.2 and 1000 lb static load while also CAL TB133 compliant.



Generous seat width coordinates with appropriate seat and arm height for proper ergonomics and easy egress.

Ballasting option available on plinth base

Premium TruColor™ polymer is fully compounded for superior color consistency and durability.

Arm Lounge

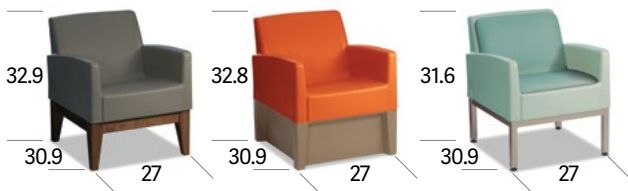

Armless Lounge

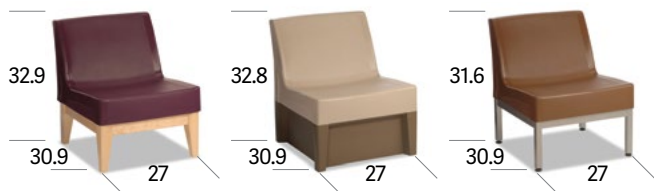

Options: Upholstery, Ganging Kit, Bolt-Down Kit, CAL TB 133 Upgradeable Upholstery, Ballasting (Plinth Base Only)

Testing: GREENGUARD Gold Certified, California Technical Bulletin 117-2013, UL1056, ASTM E1537, NFPA 261, UL94 HB, British Standard BS 7176: 2007, BIFMA 5.4 15.4.2, 1000 lb Static Load



Forté® Guest

Hundreds of upholstery options.

Generous seat width coordinates with appropriate seat and arm height for proper ergonomics and easy egress.

Premium TruColor™ polymer is fully compounded for superior color consistency and durability.

Non-removable steel encased floor glides for floor protection.



Extremely durable, one-piece rotationally-molded polyethylene seat is impervious to fluids and incredibly impact resistant.

Molded-in access port with threaded screw cap for ballasting.



Molded-in steel threaded inserts provide secure steel-to-steel connections and optional ganging side to side.

Arm Guest

This guest chair includes all of the comfort, durability and beauty of our armless chair, plus the additional comfort of arm support that provides hand over ankle positioning for easier egress.



Armless Guest

Our guest chairs are made of one-piece rotationally-molded polyethylene and are manufactured with ergonomic contours that provide support. These chairs are pitched slightly forward and allow for comfortable sitting at tables.



Guest and Lounge Seat Colors



Options: Upholstery, Ganging Kit, Bolt-Down Kit, CAL TB 133 Upgradeable Upholstery, Ballasting

Testing: GREENGUARD Gold Certified, California Technical Bulletin 133, BIFMA 5.4 15.4.2, 750 lb Static Load



Wink™ Lounge Series

This is Wink, a lounge chair with attitude, aesthetics and durability to boot. It's a cure for the ordinary, with a wide array of colors and fabrics to choose from. It's cool. It's hip. And its bold curves make other chairs seem... well ... square.

Premium TruColor™ polymer is fully compounded for superior color consistency and durability.

Generous cushion width coordinates with appropriate seat and arm height for proper ergonomics and easy egress.

The seat features a side wipeout and back cleanout for easy cleaning.

Smooth, continuous molded surface allows for easy cleaning.

Tamper-resistant steel encased floor glides for floor protection.

Molded in access port with threaded screw cap for ballast weighting capability.



Seat Colors



Options: Upholstery, Ganging Kit, Bolt-Down Kit, CAL TB 133 Upgradeable Upholstery

Testing: GREENGUARD and GREENGUARD Gold Certified, ANSI/BIFMA X5.4-2012, UL2818. UL.COM/GG, UL1056, ASTM E1537, 750 lb Static Load

Mix-Up™

Mix-Up is a furniture line from Norix that allows you to use five different shaped products to produce endless configurations. This diverse series is perfect for dayrooms, lobbies or any area where playful, attractive and durable furniture is applicable. Endless upholstery options and three base colors allow facilities to pick an aesthetic that perfectly matches their environment. Choose products that are round, square, wedge, and rectangle. Then ... well ... mix them up!

Shapes

Mix-Up pieces are highly configurable due to their variety in shapes. The *upholstered* products are designed in round, square, wedge, and rectangles. This allows you to mix and match different forms to create highly customized configurations that meet your facility's requirements or vision. Want to use the rectangles to create a square? You can do that. Mix and match shapes to create your own artistic configuration? Sure. Use these products to accompany other Norix product lines? Go for it!

Materials

Mix-Up can bring a pop of color or a calming element to facilities due to the enormous *upholstery* options available. Choose *upholstery* in different grades, colors, patterns, materials and price points to fit your budget and requirements. High density foam inside the chair allows for comfortable yet stable sitting, while the base is made of high impact polyethylene that is available in three neutral colors, each of which pairs well with nearly all upholstery options.

Five different shapes allow for endless configurations.

High density foam interior provides stability and comfortable sitting.

Ample upholstery options in different grades, colors, patterns, materials and price points.

High-impact polyethylene bases available in three colors.



Base Colors



Testing: GREENGUARD Gold Certified, California Technical Bulletin 117, BIFMA 5.4 15.4.2, 1000 lb Static Load



Hondo Nuevo® Series

A line of unique furniture that combines superior durability, comfort and style and that includes chair, bench and wedge options that allow for flexible, modular seating arrangements. Hondo Nuevo® is specially designed for facilities where robust products are a must.

Robust Durability

Smooth, exterior surface is impervious to fluids and highly puncture resistant, yet easy to clean and sanitize. Fabricated drip edge allows moisture to run off the chair and not into the base.

3 lb density polyurethane foam filling for cushioned comfort.

Seamless chemically resistant surface is easy to clean and sanitize.

Meets the stringent ANSI/BIFMA X5.4-2005 furniture standard, dynamic drop tested to a relative impact force of two times BIFMA 5.4 15.4.2 and 750 lb static load while also Cal TB133 compliant.



Extremely durable, 1/4" thick rotationally-molded skin is impervious to fluids and puncture resistant to 184 lbs.

Premium TruColor™ polymer is fully compounded for superior color consistency and durability.

High Back Chair

The high back option offers facilities yet another tool to help humanize and secure their environments. High back chairs offer comfortable and supportive seating for geriatric populations and patients who may be immobilized or medicated.

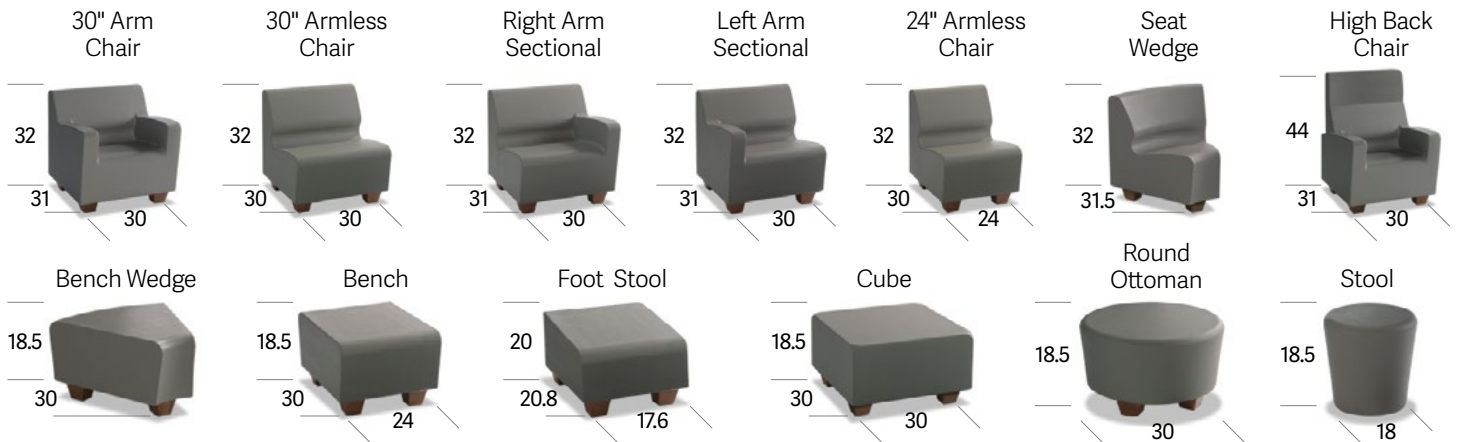
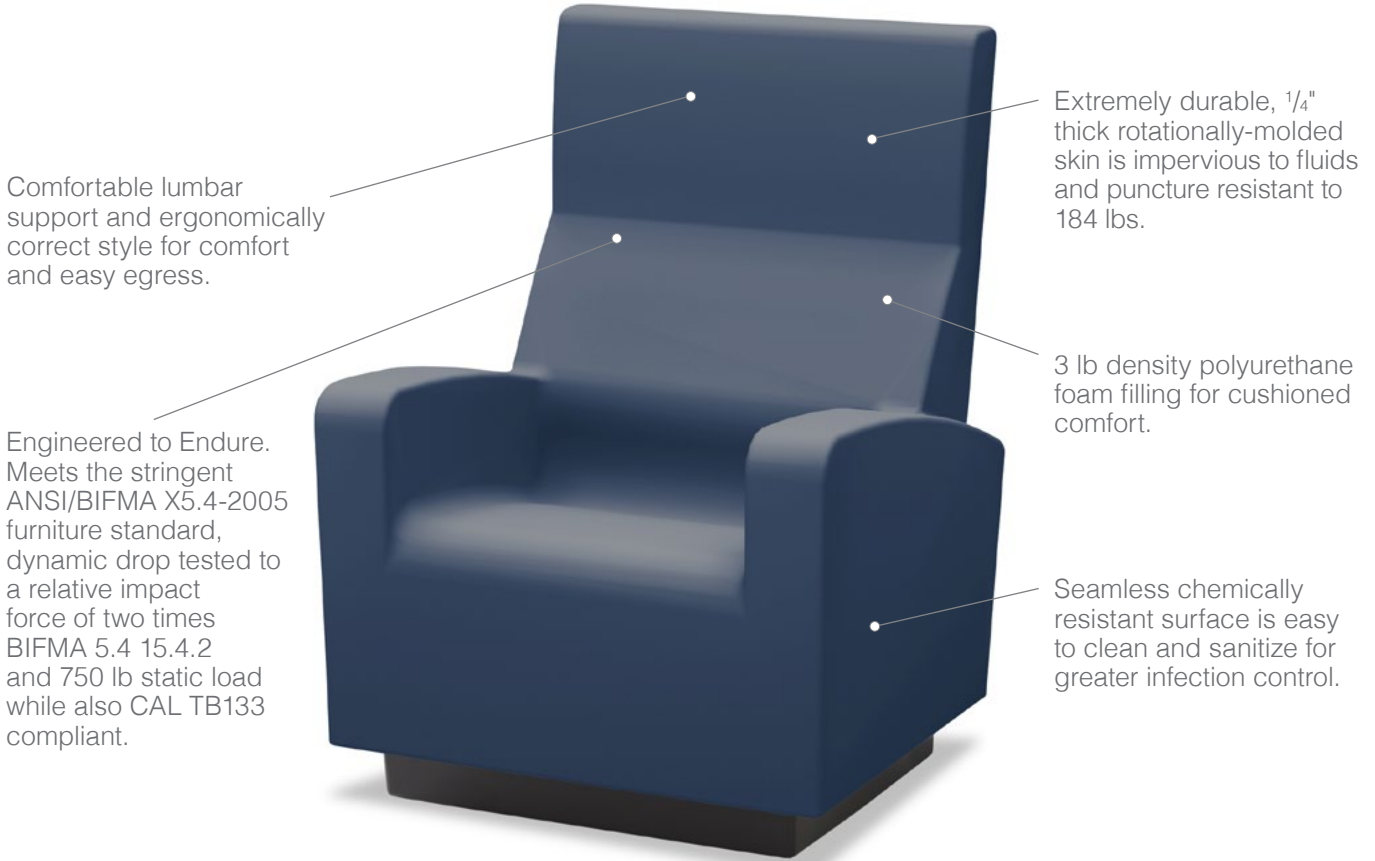

Seat Colors



Molded Wood Base Colors



Molded Plinth Base



Steel Base Color



Options: Ganging Kit, Bolt-Down Kit

Testing: GREENGUARD Gold Certified, California Technical Bulletin 133, British Standard BS 7176: 2007; ASTM E1537 NFPA 261, UL1056, UL94 H, BIFMA 5.4 15.4.2, 750 lb Static Load



Jupiter Weighted-Down Tables

Sometimes you want a table that is easy to move around. Other times, you'd like that table to stay in one place, but you don't want to anchor it to the floor. Enter the Norix Jupiter Table. Jupiter is designed to be weighted on site to maintain space flexibility and allow for efficient floor maintenance as the needs of an environment change. Base is able to be ballasted to keep the table in place.



Kensington Maple Laminate Coordinated Edge



Wild Cherry Laminate Coordinated Edge



Walnut Laminate Coordinated Edge

Finish on the Top

We use the toughest grade available and seal it with a specially formulated, highly durable molded urethane edge. The permanently affixed edge has a radius profile for safety and comfort making it ideal for food service applications. We can also provide our exclusive game top pattern that includes checkers, chess, backgammon and solitaire. Popular top sizes are available in either Plain or Game Top and come in 36" Round and Square; 42" Round and Square, and 48" Round.



Special 1 1/2" thick table top for additional strength.

Molded edge is radiused for safety and comfort, pressure fused to the top, rendering it firmly attached and highly sanitary.

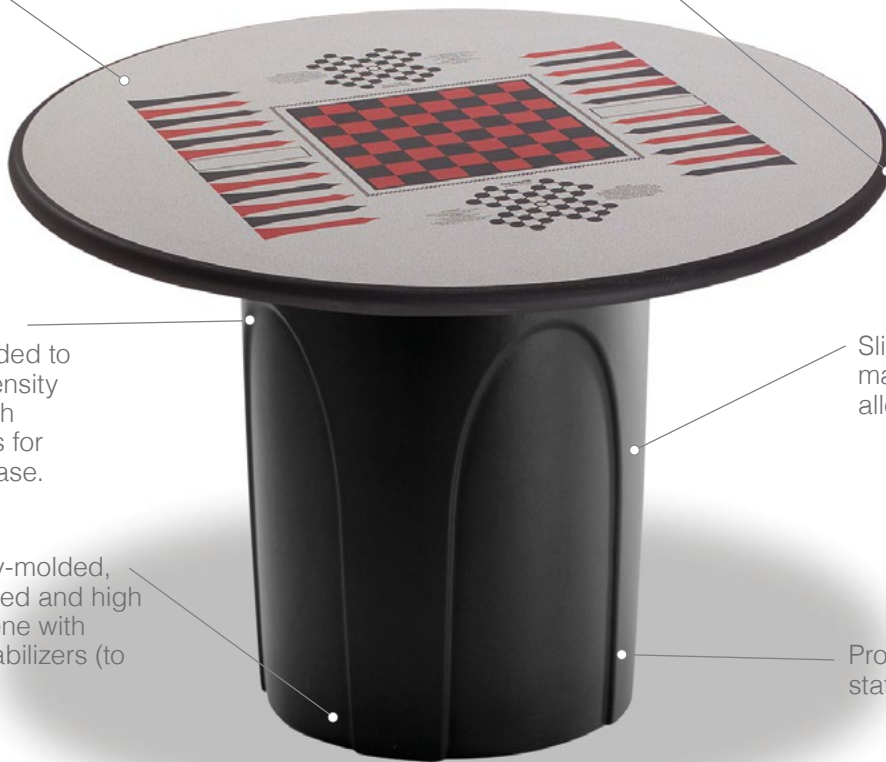

Selected material permanently bonded to a core of 45 lb density particle board with embedded T-nuts for securing top to base.

Slightly textured maintenance-free surface allows for easy cleaning.

Base: Rotationally-molded, specially formulated and high impact polyethylene with ultraviolet light stabilizers (to reduce fading).

Product tested to 1,000 lb static load.

Titanium Evolve Game Top laminate with Black Edge.

General Dimensions



Laminate

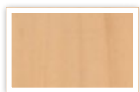

Maple

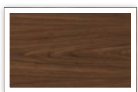

Walnut

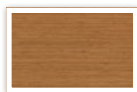

Asian Sun

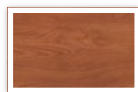

Wild Cherry

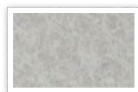

Titanium Evolve



Titanium Evolve Game Top

Base & Top Edge



Raven

(Raven top edge only available in Game Top)

Testing: GREENGUARD Gold Certified, California Technical Bulletin 133, UL1056, ASTM E1537, UL94 HB, NFPA 261, British Standard BS 7176: 2007, 1000 lb Static Load

X-Base Series

Years ago, we were challenged to design an institutional-grade table that defined each person's space and hindered the passing of contraband from one individual to another on the opposite side. Our answer was the popular, rugged X-Base Table with its unique "X" base design. Today, the X-Base Table is used in high-security and special needs facilities all across the country.

Premium Top

High quality laminate surface with an edge that is pressure fused to the core with a specially formulated, highly durable molded urethane material. The permanently affixed edge has a radius profile for safety and comfort, making it exceptional for food service applications. We can also provide our exclusive game top pattern that includes checkers, chess, backgammon and solitaire.

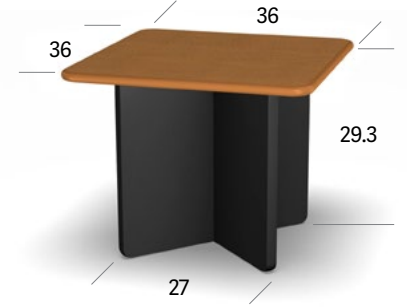

Molded edge is radiused for safety and comfort, pressure fused to the top, rendering it permanently non-removable and highly sanitary.

Special 1 1/2" thick table top for additional strength.

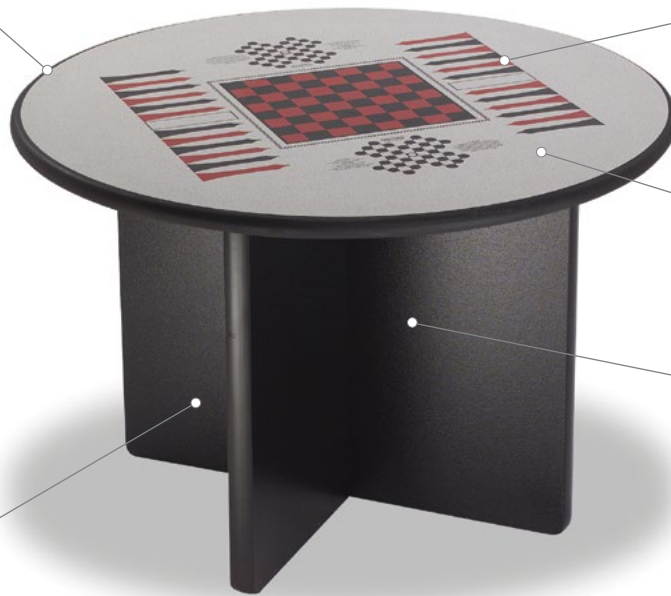

45 lb density particle board, with embedded T-nuts for securing the top to the base. high-pressure laminate sealed with a specially formulated, highly durable Slammer Stone edge.

Heavy duty durable, tamper-resistant "X" base style. Engineered and suitable for continuous use in behavioral health environments.

Product tested to 1000 lbs static load.

General Dimensions



Laminate Tops

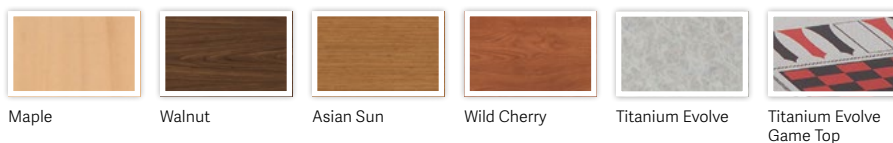

Base & Top Edge

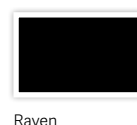

(Raven top edge only available in Titanium Evolve & Game Top)

Testing: GREENGUARD Gold Certified, 1000 lb Static Load



Max-Master Series

Engineered for superior strength and durability, the Max-Master Series is particularly well suited for dining halls and dayrooms where reliable performance is a must. Whether bolted to the floor or freestanding on adjustable glides, the distinctive individual seat/leg design provides superior stability than traditional pedestal tables. Compression molded composite seats, premium table top and unique steel leg design delivers an exceptional table for continuous daily use in challenging environments.

Choice of laminate or steel tops with 4, 6 or 8 seats. Engineered and suitable for continuous daily use in an institutional environment.

Permanently embedded T-nuts secure top to base with tight steel-to-steel connection for maximum long term reliability.

3" diameter, 14 gauge steel tubing.

13" diameter high density color impregnated compression molded composite that is highly scratch and stain resistant.

Tested to 1,000 lbs static load.

Premium M3 Grade, 45 lb density particle board table top core is sandwiched between 1/8" thick hardboard and faced with premium .05" thick high pressure laminate for superior quality and long term durability.

Molded edge is radiused for safety and comfort, pressure fused to the top, rendering it firmly attached and highly sanitary.

Four molded-in threaded inserts for superior metal-to-metal connection.

Non-removable glides (or bolt-down).



Seat Colors



Steel Base Color

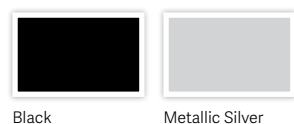

Tops Options

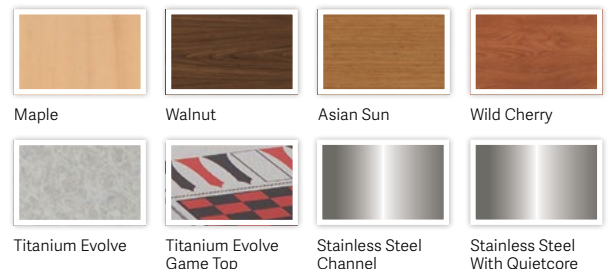

*Available in select styles: Game Top, Stainless Steel Channel and Stainless Steel with Quietcore.

Options: Leg Protectors, Stainless Steel Seats, Non-Removable Glides, Bolt-Down

Testing: GREENGUARD Gold Certified, 1000 lb Static Load



Oasis® Cafeteria

If your environment demands a more robust solution for cluster seating, your search is over. The Oasis® Series is designed and engineered specifically for dayrooms, dining halls and visitation areas. Oasis® is perfect for situations where users need more back support than traditional stools provide.

Safety & Comfort

Oasis' innovative swivel seats allow easy access and provide the comfort of full lumbar support. The molded polyethylene seat shells are durable and easy to clean. Seats attach securely to reinforced, heavy-duty swivel plates with all-steel, tamper-resistant connections.



Superior Performance

The Oasis® table top delivers superior performance, day in and day out, year after year. High-quality laminate surface features a rounded edge that is pressure-fused to the core with a specially formulated, highly durable molded urethane material. Edges are permanently affixed to the top, making it highly sanitary – ideal for food service applications. Also available in a special ADA version with a reinforced 72" long table top.

Strength & Security

A sturdy 14 gauge steel frame gives Oasis® its rock-solid foundation. The rugged frame provides seat support and understructure for the table top. The bottom of the vertical seat tube has a fully welded plate that holds either a large-stem adjustable glide or an enclosed, non-removable anchor bolt for floor-mounting.



Premium TruColor™ polymer is fully compounded for superior color consistency and durability.

45 lb density M3 grade particle board, with permanently embedded T-nuts for securing the top to the base.

Tested to 1,000 lbs static load.

Ergonomic seats provide back support and swivel for easy access and egress. Fixed seat also available.

One-piece seat and back. Smooth, non-absorbent surface is easy to clean.

Molded-in threaded steel inserts provide for tamper-resistant, steel-to-steel attachment to reinforced seat support plate.

Non-removable glides (for bolt-down).

Molded edge is radiused for safety and comfort, pressure fused to the top, rendering it permanently non-removable and highly sanitary.

Heavy-duty cluster seating. Designed and engineered specifically for intensive-use environments such as dayrooms and dining areas.

General Dimensions

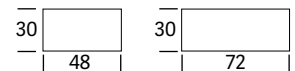

Seat



Tops (Laminate & Metal)

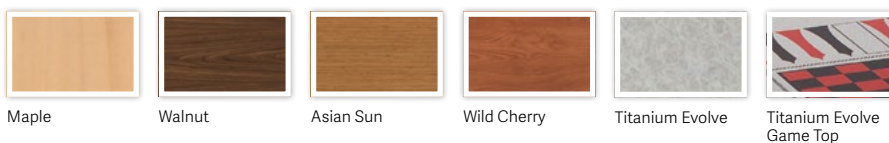

Steel Base Color

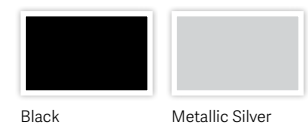

Options: Non-Removable Glides, Bolt-Down, Swivel or Fixed Seats, ADA version

Testing: GREENGUARD Gold Certified, 1000 lb Static Load



Forté® Guest

Hundreds of upholstery options.

Generous seat width coordinates with appropriate seat and arm height for proper ergonomics and easy egress.

Premium TruColor™ polymer is fully compounded for superior color consistency and durability.

Non-removable steel encased floor glides for floor protection.

Extremely durable, one-piece rotationally-molded polyethylene seat is impervious to fluids and incredibly impact resistant.

Molded-in access port with threaded screw cap for ballasting.



Arm Guest

This guest chair includes all of the comfort, durability and beauty of our armless chair, plus the additional comfort of arm support that provides hand over ankle positioning for easier egress.



Armless Guest

Our guest chairs are made of one-piece rotationally-molded polyethylene and are manufactured with ergonomic contours that provide support. These chairs are pitched slightly forward and allow for comfortable sitting at tables.



Guest Seat Colors



Canyon

Wild Berry

Meadow

Mojave

Pine Cone

River Rock

Lagoon

Sea Spray

Graphite



Options: Upholstery, Ganging Kit, Bolt-Down Kit, CAL TB 133 Upgradeable Upholstery, Ballasting

Testing: GREENGUARD Gold Certified, California Technical Bulletin 117-2013, UL1056, ASTM E1537, NFPA 261, UL94 HB, British Standard BS 7176: 2007, BIFMA 5.4 15.4.2, 750 lb Static Load

Integra Armless

Integra chairs are specifically designed for intensive use applications, yet comfortable and lightweight. They're molded in one-piece so you don't have to worry about assembled components coming loose. They're stackable and they pass the rigid California Technical Bulletin 133 Flammability Test.

Each chair weighs only 7 lbs so stacking 15 of them in a seven foot high space is easily accomplished.



Molded from high-impact grade copolymer polypropylene. Passes the rigid California Technical Bulletin #133 Flammability Test.



Unique leg shape and 1 1/2" deep "X" ribs molded into the seat bottom for superior strength.

Seat Colors



Options: 3 Wheel Dolly

Testing: GREENGUARD Gold Certified, ISO 14001:2015, UL 2818. UL.COM/GG., NFPA 261

Sled Base Series

Residential room furnishing designed to coordinate with Safehouse® Series furniture. The Safehouse® Sled Based Chairs are a collection of real wood seating that is built to last – beautifully.

Assembled with durable fasteners and securely doweled and glued at strategic locations.

Solid hardwood frame with rounded edges for safety and security.

Available in solid wood seat or upholstered seat and back.

Seat



Oak

Cherry



High performance clear catalyzed lacquer finish.

3/4" thick and 2" wide solid hardwood frame with rounded edges for safety and security.



Options: CAL TB 133 Upgradeable Upholstery

Leg Style Series

When you start with 4" diameter 14 gauge tubular steel legs fully welded to 1/4" steel mounting plates, you end up with an incredibly strong, stable and durable table. The legs are joined to the top using tamper-resistant screws connected to embedded T-nuts, for a secure steel-to-steel connection. Optional 2 1/2" legs provide an attractive residential alternative. Legs are solid as a rock. Lean on it with all your weight. The Leg Style table won't wobble or tip. That's peace of mind.



What's On Top

We pressure fuse our top to the core with a specially formulated, highly durable molded urethane edge. The permanently affixed edge has a radius profile for safety and comfort making it exceptional for food service applications. We also can provide our exclusive game top pattern that includes checkers, chess, backgammon and solitaire.

Under & Beyond

The Leg Style table is engineered and built for continuous daily service in any behavioral health environment, but sometimes you want to make sure it stays put. In addition to super tough, tamper-resistant adjustable glides, we also give you the option of bolt-down tabs ... just to be sure.

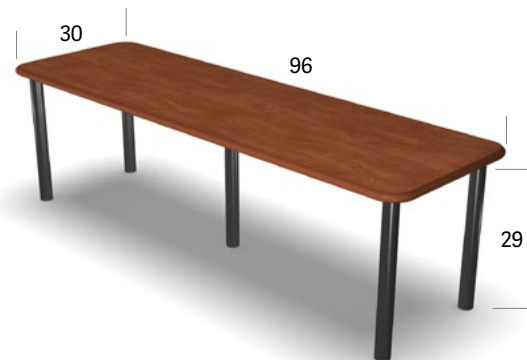

Permanently bonded to a core of 45 lb density M3 grade particle board with permanently embedded T-nuts for securing top to base with a metal-to-metal connection.

Product tested to 1,000 lb static load.

Robust 14 gauge steel tubing in 4" or 2.5" diameter welded to 6" steel plate for attaching to the top.

Molded edge is radiused for safety and comfort, pressure fused to the top, rendering it firmly attached and highly sanitary.

Heavy duty leg style tables built for stability. Engineered and suitable for continuous daily use in an institutional environment.

Bottom of leg sealed by fully welded insert threaded to accommodate a non-removable adjustable leveling glide.



General Dimensions

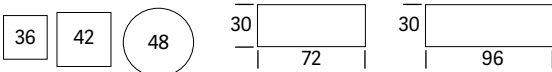

Laminates



Leg Color

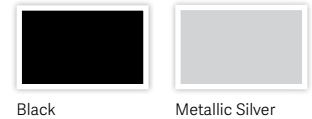

Options: Bolt-Down, Non-Removable Glides, 2 1/2" or 4" Diameter Legs

Testing: GREENGUARD Gold Certified, 1000 lb Static Load



Forté® Café Tables

Molded cylindrical hour glass base pairs with Forté® Guest Chairs. Available as a one piece polymer table or with optional laminated top options. Engineered and proven suitable for daily use in demanding environments.



Product tested to 1,000 lbs static load.

Selected laminate material permanently bonded to a core of 45 lb density particle board with permanently embedded T-nuts for securing top to base.



Polyurethane edge is radiused for safety and pressure fused to the top, rendering it permanently non-removable and highly sanitary. 1 1/2" thick edge profile.

Polyurethane edge is radiused for safety and pressure fused to the top, rendering it permanently non-removable and highly sanitary. 1 1/2" thick edge profile.

One-piece rotationally-molded polyethylene with lightly textured maintenance-free surface which allows for easy cleaning. Specially formulated, high-impact polyethylene with ultraviolet light stabilizers.

Your Top, Your Base, Your Size

The Forté Cafe table is available in a variety of sizes, tops and options. Select the tables that fit your space perfectly.

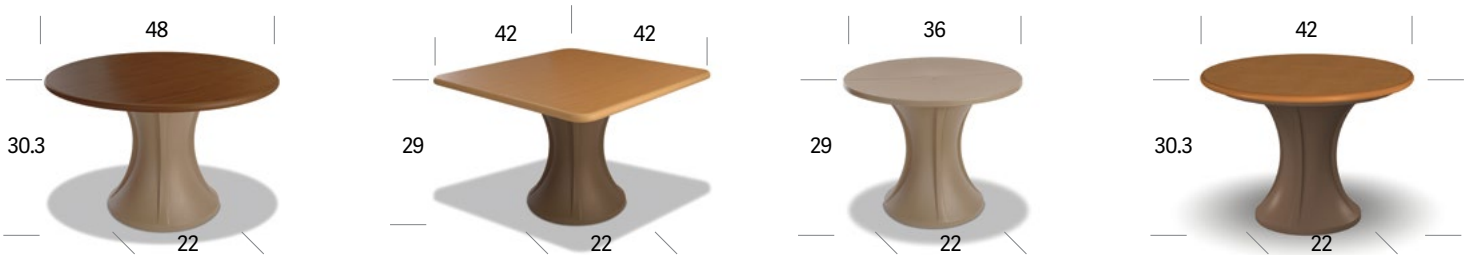

Laminates



Molded Plinth Base

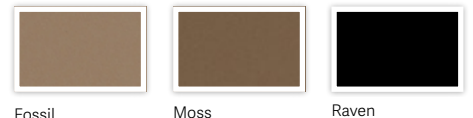

Testing: GREENGUARD Gold Certified California Technical Bulletin 133, UL1056, ASTM E1537, NFPA 261, UL94 HB, British Standard BS 7176: 2007, 1000 lb Static Load



Max-Master Series

Engineered for superior strength and durability, the Max-Master Series is particularly well suited for dining halls and dayrooms where reliable performance is a must. Whether bolted to the floor or freestanding on adjustable glides, the distinctive individual seat/leg design provides superior stability than traditional pedestal tables. Compression molded composite seats, premium table top and unique steel leg design delivers an exceptional table for continuous daily use in challenging environments.

Choice of laminate or steel tops with 4, 6 or 8 seats. Engineered and suitable for continuous daily use in an institutional environment.

Permanently embedded T-nuts secure top to base with tight steel-to-steel connection for maximum long term reliability.

3" diameter, 14 gauge steel tubing.

13" diameter high density color impregnated compression molded composite that is highly scratch and stain resistant.

Tested to 1,000 lbs static load.

Premium M3 Grade, 45 lb density particle board table top core is sandwiched between 1/8" thick hardboard and faced with premium .05" thick high pressure laminate for superior quality and long term durability.

Molded edge is radiused for safety and comfort, pressure fused to the top, rendering it firmly attached and highly sanitary.

Four molded-in threaded inserts for superior metal-to-metal connection.

Non-removable glides (or bolt-down).



Seat Colors



Steel Base Color

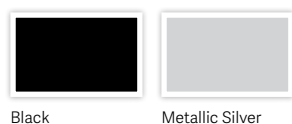

Tops Options

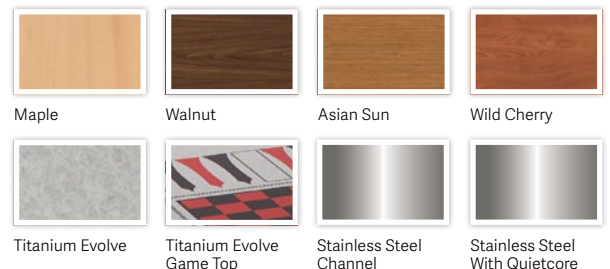

*Available in select styles: Game Top, Stainless Steel Channel and Stainless Steel with Quietcore.

Options: Leg Protectors, Stainless Steel Seats, Non-Removable Glides, Bolt-Down

Testing: GREENGUARD Gold Certified, 1000 lb Static Load



Terra Seating Series

Terra is a seating series from Norix with a wide assortment of offerings that allow facilities to create highly customized configurations from one product line. That means no more endless searching for furniture that meets your specific needs. Terra is tailored for one-stop shopping for highly durable and aesthetically pleasing integrated seating.

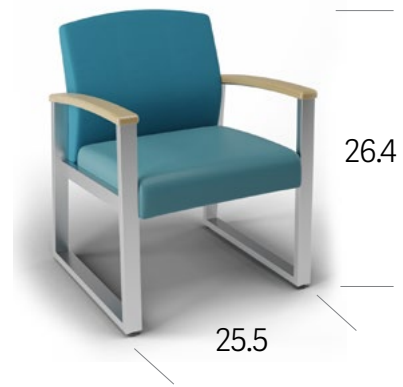

Tons of Seating Options

Seats and backs are constructed with heavy duty wood encased in foam. Hundreds of upholstery options are available in different fabrics, grades and price points, giving facilities the opportunity to match the furniture to their space.

Arm caps available in black polyurethane or in maple, teak and walnut wood color.

Choose from black or metallic silver frames.

Tamper-resistant non-removable nylon glide.



Hundreds of upholstery options.

Top stitched and with no exposed staples to provide extra security.

3 arm options

Enclosed bottom panel for security.
(optional ballast plate available)



Frame Colors



Black



Metallic Silver

Wood Arm Caps



Maple



Walnut

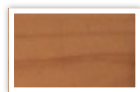

Teak

Urethane Arm Caps



Black



Options: CAL TB 133 Upgradeable Upholstery

Testing: GREENGUARD and GREENGUARD Gold Certified, UL 2818. UL.COM/GG, BIFMA 5.4 15.4.2, ANSI/BIFMA X5.4-2012, 750 lb static load



Forma Series

To provide customers and facilities with one source for all of their furniture needs, Norix has expanded its offerings with Forma, a modular upholstered seating line that is designed with attractive features and engineered to be highly durable. The ten pieces in this designer-friendly line of products – arm chairs, cubes, benches and wedges – are ideal for lobbies, waiting rooms, staff areas and supervised areas such as group therapy and activity spaces.



Endless Configurations

Facilities can choose from plinth or steel bases, while Norix's expansive upholstery offerings give customers hundreds of options in different grades, fabrics and price points. Products can be bolted down, ganged or left free-standing, providing facilities maximum flexibility if new configurations are needed in the future or if furniture needs to stay in one place. Forma provides a high level of versatility and can help facilities with all of their furniture needs across their entire environment.



Steel Color



Metallic Silver

Molded Base Colors

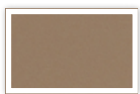

Fossil

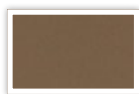

Moss



Raven

Laminate Cube Top Colors



Kensington Maple

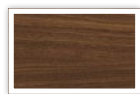

Montana Walnut

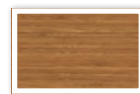

Asian Sun

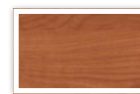

Wild Cherry

Options: CAL TB 133 Upgradeable Upholstery

Testing: GREENGUARD and GREENGUARD Gold Certified, UL 2818. UL.COM/GG, ANSI/BIFMA X5.4-2012, 750 lb static load





Harmony™

The Harmony™ Series blends form and function to deliver the unique combination of exceptional durability and a residential look for facilities that need residential products for their challenging environments. Limited lifetime warranty for structural integrity. In spite of that rugged interior, the Harmony™ Series is elegant, versatile and aesthetically pleasing.

Superior Construction

Interior steel frame for unparalleled structural integrity. Arm chair weighs 130 lbs. Love seats, sofas, and benches offer the same construction with more seating options.

Upholstery

Our upholstery comes in a variety of performance grades so you can choose the appropriate vinyl for your facility. Both seat and back cushions are field replaceable.



Arm Chair



High Back Chair



Love Seat



Sofa

Armless

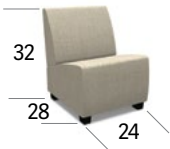

32
28
24

2 Seat Bench

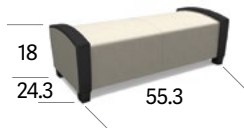

18
24.3
55.3

3 Seat Bench

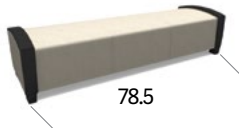

78.5

Coffee Table

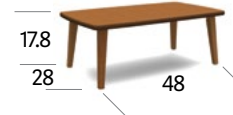

17.8
28
48

End Table



18
28
28

Arm Cap/Feet



Raven



Options: Round or Square Back, Full or Short Apron, Clean Out or Standard Fit, Open or Closed Bottom, CAL TB 133 upgradeable upholstery

Testing: GREENGUARD Gold Certified, California Technical Bulletin 117, BIFMA 5.4 15.4.2, 1000 lb Static Load

Element™

Element™ is a designer-friendly series of lounge furniture that provides facilities with reliable performance. Mix and match the Element™ Lounge Chair, Love Seat and Sofa throughout your facility depending upon the needs of spaces.



Durability

Element is highly durable due to construction and the materials. On the inside, Element is supported by a sturdy milled-wood frame that is connected with metal hardware to ensure durability and longevity. On the outside, the arm rests are protected and covered with a specially formulated arm cap. These arm caps are available in black and are mounted to the wood frame with steel T-nuts.

Features and Benefits

Whether you are picking a lounge chair, loveseat or sofa, Element will add to or create an aesthetic appeal in dayrooms, lounges, lobbies or other areas in your facility where you need attractive furniture. Additionally, the series was designed to last and is appropriate for constant-use environments in facilities that see lots of traffic.

Clean out between seat and back allows dirt and debris to fall to the ground rather than gather in chair.

Specially formulated arm cap attached to frame with T-nuts.

Upholstery available in a variety of patterns and grades.



Injection-molded nylon feet are engineered for strength and to protect floors.

Frame is made of heavy duty milled wood for strength and durability.

Generous seat width and cushioned support provide comfortable lounging.

Upholstery

Our upholstery comes in a variety of performance grades so you can choose the appropriate vinyl for your facility. Both seat and back cushions are field replaceable.

Lounge Chair

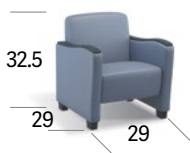

Love Seat



Sofa



Arm Cap/Feet

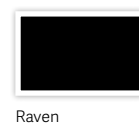

Options: Arm Caps and Feet: Raven, CAL TB 133 upgradeable , upholstery

Testing: GREENGUARD and GREENGUARD Gold Certified, ANSI/BIFMA X5.4-2012 , UL.COM/GG, BIFMA 5.4 15.4.2, 1000 lb Static Load



Gibraltar™ Series

At last, a collection of in-line seating that delivers intensive-use security and durability in a sleek, contemporary design. Gibraltar™ is designed to survive the rigors of continuous use – and look great doing it.

Premium TruColor™ polymer is fully compounded for superior color consistency and durability.

Extremely durable one-piece molded polyethylene seat and back. Smooth, seamless non-absorbent surface is easy to clean.

2" diameter, 14 gauge tubular steel, bent and welded to provide arm or armless in-line seating. Standard configurations for 1 to 4 people.



Engineered to Endure. Dynamic drop tested to a relative impact force of two times BIFMA 5.4 15.4.2 and 1000 lb static load while also Cal TB133 compliant.

Heavy duty flat steel plate welded to the frame at each seat location to provide strength, support and a mounting platform on which the seat is securely attached.

Seat Colors



Canyon



Wild Berry



Meadow



Pine Cone



Lagoon



Raven

Frame



Metallic Silver

Options: Free-standing unit with tamper-resistant, nylon-bottom leveler glides, or fitted with steel tabs for bolt-down installation, end and divider arms.

Testing: GREENGUARD and GREENGUARD Gold Certified, UL 2818. UL.COM/GG, UL1056 Fire Test, ASTM E1537, NFPA 261, 1,000 lb static load



Affinity Seating

Affinity. A natural liking for, or attraction to a person, idea, or thing. That thing from Norix is a chair, but not just any chair. Affinity represents the great length Norix engineers have gone to create a chair that blends attractive form, comfort, versatility, and reliability.

Affinity combines a metallic silver frame with hundreds of seat and back options. Available with or without arms, and optional upholstered or wood back, the chair makes a great companion to the broad assortment of Norix tables. Contrasting fabrics are available for an even more dynamic look.

The elegant appearance of Affinity lends itself extremely well to lobbies, meeting spaces, and dining areas.



Wood Back Color Options



Walnut (Stain)



Maple

Urethane Arm Caps



Black



Options: CAL TB 133 Upgradeable Upholstery

Testing: GREENGUARD and GREENGUARD Gold Certified, UL 2818. UL.COM/GG, ANSI/BIFMA X5.4-2012, 500 lb static load



Forté® Lounge

Forté® is the designer series of furniture that is fashioned for comfort, flexibility and durability. With a variety of colors to choose from and an upholstery option for seating, this series is made to humanize behavioral health environments and includes a lounge chair and guest chair that come with or without arms. These products are engineered and proven suitable for daily use in demanding environments.

Seat Colors



Extremely durable, one-piece rotationally-molded polyethylene seat is impervious to fluids and incredibly impact resistant.

Molded-in steel threaded inserts provide secure steel-to-steel connections and optional ganging side-to-side.

Dynamic drop tested to a relative impact force of two times BIFMA 5.4 15.4.2 and 1000 lb static load while also CAL TB133 compliant.



Generous seat width coordinates with appropriate seat and arm height for proper ergonomics and easy egress.

Ballasting option available on plinth base

TruColor™ Premium material is fully compounded for superior color and quality assurance.

Wood Base

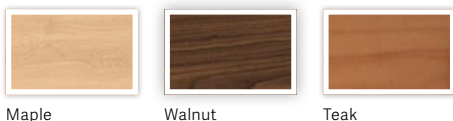

Molded Base



Steel Base



Options: Upholstery, Ganging Kit, Bolt-Down Kit, CAL TB 133 Upgradeable Upholstery, Ballasting (Plinth Base Only)

Testing: GREENGUARD Gold Certified, California Technical Bulletin 117-2013, UL1056, ASTM E1537, NFPA 261, UL94 HB, British Standard BS 7176: 2007, BIFMA 5.4 15.4.2, 1000 lb Static Load

Arm Lounge

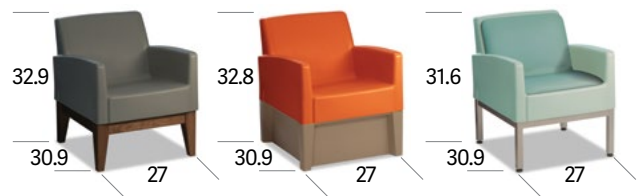

Armless Lounge

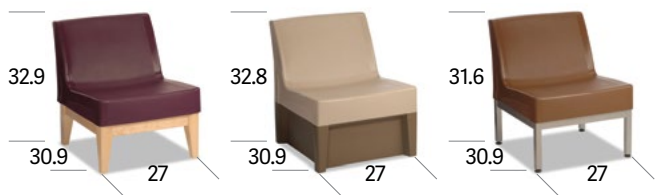

Forté® Occasional Table

Free standing occasional tables can be optionally ganged with lounge seating for intermediate or corner tables. Choose one of three base options, wood, steel or molded polymer and pair with your choice of molded polymer or laminate top with permanently affixed urethane edge. All tops come with embedded T-nuts for a secure steel-to-steel connection.



Polyurethane edge is radiused for safety and pressure fused to the top, rendering it permanently non-removable and highly sanitary. 1³/₄" thick edge profile.

Decorative high pressure laminate is permanently bonded to a core of 45 lb density particle board with permanently embedded T-nuts for securing top to base.



Cut, formed and welded steel. 1¹/₂" square steel tubing with 12 gauge structural members.

Molded Top Colors



Laminates

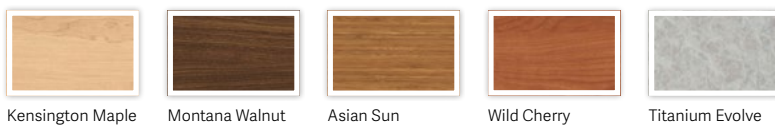

Wood Base Colors

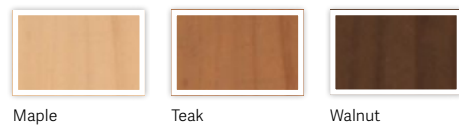

Molded Plinth Base



Steel Base Color



Testing: GREENGUARD Gold Certified, California Technical Bulletin 117-2013, UL1056, ASTM E1537, NFPA 261, UL94 HB, British Standard BS 7176: 2007, BIFMA 5.4 15.4.2, 1000 lb Static Load

NEW!



ANTI-LIGATURE

Careful flush to the floor design avoids tie offs.

TAMPER RESISTANT

One-piece security conscious design for greater safety.

UNMATCHED CLEANABILITY

Non-absorbent polymer for greater infection control.

Prodigy Bedroom

Warmth of Wood, Performance of Polymer

Prodigy features the latest Norix innovations in an uncompromising line of high performing and aesthetically pleasing bedroom furniture. It is designed and engineered to overcome the daunting challenge of creating a humanized environment without sacrificing safety, security and long term performance. Prodigy is at the vanguard of innovation and advances the Norix legacy of spearheading breakthroughs in behavioral healthcare. Patent Pending.

Crafted in a specially forged polymer with proprietary innovations to deliver superior durability, maintenance free cleanability and humanizing aesthetic appeal. Each piece is uniquely fashioned with specialized TruGrain polymer to replicate natural wood and deliver a residential, non-institutional appearance.

Colors



Harvest



Java

Therapeutically Attractive

Attractive wood grain appearance to enhance the calming familiarity of a home-like environment.

Designed for Safety

Superior to wood in infection-control and ligature, fluid, tamper, infestation and contraband resistance. Concealed anchoring.

Durable

Structurally reinforced for superior durability, impact resistance and security.

Maintenance-Free

Seamless one-piece construction delivers unmatched cleanability and long-term, maintenance-free performance.

Environmentally Responsible

Recyclable polymer is made responsibly with recycled content.



Proprietary TruGrain™ aesthetic provides authentic texture and gradation that replicates natural wood. Each piece is uniquely fashioned to deliver a residential, non-institutional appearance. Special polymer delivers superior durability, maintenance-free cleanability, and humanizing aesthetic appeal. Patent Pending.



EXTREMELY DURABLE
Impact resistant and tested to 1,500 lbs. static load.

TRUGRAIN™ TECHNOLOGY
Warmth of wood, performance of polymer.

CONTRABAND RESISTANT
Residential inset panel allows for flush wall mounting.

CONCEALED HARDWARE
For secure and attractive floor anchoring.



Panel Bed

Anti-ligature bed with inset panel design aesthetic creates a “classic” residential look yet allows placement flush against wall or in corners. Raised lip on bed deck with grooved sleep surface for fluid management. Select free-standing version with fully closed bottom or floor-anchor model (all anchoring hardware included.) Optional restraint rings.



Nightstand

The Prodigy Nightstand is the perfect complement to the Panel Bed. Smaller top cubby keeps essentials within easy reach; bottom cubby holds larger items. Includes all anchoring hardware for floor mounting and non-removable floor guide kit for a free-standing alternative.



Open Chest

Ideal anti-ligature solution - storage for larger items with no doors, drawers or hinges. Includes all anchoring hardware for floor mounting and non-removable floor guide kit for a free-standing alternative.



Desk

Classic table desk with modesty panel. Attractive inset panel design allows for placement flush against wall or in corners.



CONTRABAND RESISTANT
Residential inset panel allows for flush wall mounting.

TAMPER RESISTANT
One-piece security conscious design for greater safety.

ANTI-LIGATURE
Careful flush to the floor design avoids tie offs.

Attenda® Series

The Attenda® Series is designed to provide the strength, safety and cleanability required for the daily rigors in healthcare environments. The key to Attenda's strength and durability is its advanced construction. Molded in specially formulated, high-impact polyethylene, each Attenda® product is structurally enhanced with rigid polyurethane foam for sound absorption and increased strength and durability.

Attenda® 13" and 18" Sleigh Bed

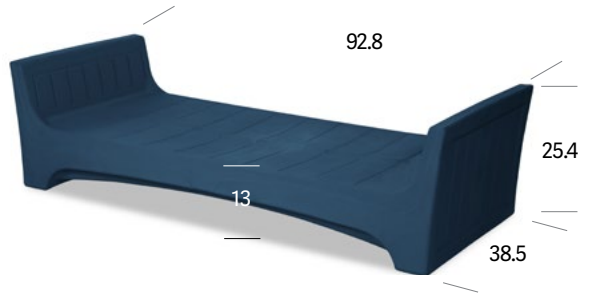

Attenda® Platform Beds

The cornerstone of the collection is the Attenda Bed - designed and engineered to exceed the expectations of practitioners who have tried everything. The Attenda Bed mounts in a corner, against a wall or free standing. Sturdy and seamless, the Attenda Bed features a raised lip around the bed deck for easy clean-up. An optional wall-mount headboard adds a touch of wood-grained style for a more residential appearance. No tie-off points make the bed the go-to choice for those looking for anti-ligature furniture products.

No tie-off points make the bed the go-to choice for those looking for anti-ligature furniture products.



Ask about our innovative NEW REMOVABLE RESTRAINT RING

Remedy Sealed Seam Mattresses



Colors

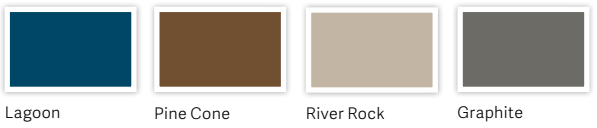

Top

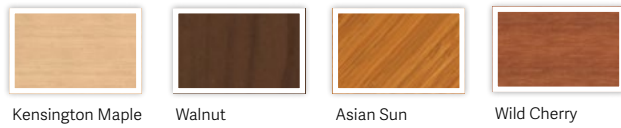

Options: Platform Bed Restraint Rings, Platform Bed Bottom Closure, No Floor Mount Holes, Headboard, Bed Riser, SafeStore

Testing: GREENGUARD Gold Certified California Technical Bulletin133, UL1056, ASTM E1537, NFPA 261, Platform Bed 1,000lb Static Load, BIFMA 5.4 15.4.2, 1000 lb Static Load

Attenda® Nightstand

The Attenda Nightstand is the ideal companion piece to the Attenda Platform Bed. Open compartments provide for accessible storage of personal articles while maintaining easy visual inspection. The advanced construction delivers unsurpassed performance in healthcare environments and makes it uniquely suited for intensive-use applications. Molded in high-impact polymer, then filled with rigid structural foam, Attenda represents the pinnacle of robust durability. In addition, the product has no moving parts or tie-off points, making it anti-ligature and safe for your BHC environment. Decorative High Pressure Laminate (HPL) top with durable resin edge is optional.



Attenda® Open Chest

The Attenda Open Chest is a particularly effective storage solution for an Attenda room ensemble. Open compartments provide ample storage capacity while maintaining easy visual inspection. Attenda's advanced construction delivers unsurpassed performance in healthcare environments and makes it uniquely suited for intensive-use applications. This anti-ligature product is safe and secure and helps decrease the risk of self-harm in your facility. Decorative High Pressure Laminate (HPL) top with durable resin edge is optional.

Attenda® Desk & Stool

Advanced construction for intensive-use applications in critical environments. Molded in high-impact polymer, and then filled with rigid structural foam. Seamless construction with rounded corners make the stool anti-ligature. Easy to clean. Bolt-down installation for safety and security. Attenda Desk features HPL top with durable molded edge as standard.

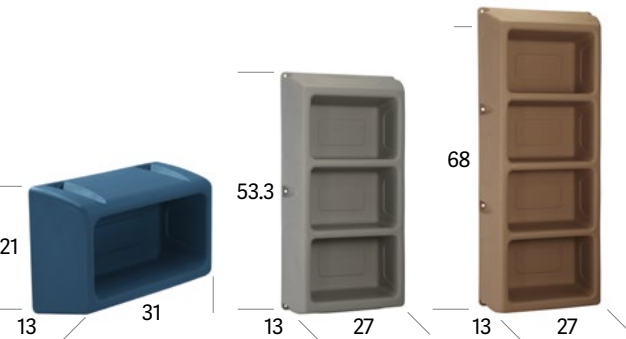

Attenda® Wall Mount Shelves

The Attenda Wall Mount Shelves are the go-to solution when free unencumbered space is at a premium. Open cubbies provide ample storage space while maintaining easy visual inspection. Attenda's advanced construction delivers unsurpassed performance in critical environments and makes it uniquely suited for intensive-use applications. Molded in high-impact polymer, then filled with rigid structural foam, Attenda represents the pinnacle of robust durability. Additionally, the product has no tie-off points, making it ligature-resistant, safe and secure.

Attenda® Wardrobe

Advanced construction for intensive-use applications in critical environments. Molded in high-impact polymer, then filled with rigid structural foam. Seamless construction with rounded corners. Easy to clean. Bolt-down installation for safety and security. Also available with no door.





Safehouse® Series Wood Case Goods

The Safehouse® Series combines safety and durability – in a homelike all-wood collection. After research and consultation with behavioral healthcare professionals, Norix designed the Safehouse collection to provide a warm, yet secure haven for residents – with client safety as the primary consideration. With built-in safety features like sloped tops, rounded edges and SafeJoint™ concealed joinery, Safehouse offers practitioners peace of mind, plus the therapeutic appeal of real wood. Norix exclusive Dura-Ply™ construction ensures that Safehouse products will stand up to the demands of your challenging environment. 5-year limited replacement warranty for defects in materials and workmanship.



Platform Bed

Residential room furnishing designed to provide a warm, yet secure haven for residents. The Safehouse Platform Bed anchors a room ensemble with the warmth of wood and the safety of durable construction. Fits a standard 36" x 80" mattress.

Remedy Sealed Seam Mattresses



Captains Bed

Residential room furnishing designed to provide a warm, yet secure haven for residents. The Safehouse Captains Bed anchors a room ensemble with the warmth of wood and the safety of durable construction. 2 built-in open storage compartments add space efficient storage. Fits a standard 36" x 80" mattress.



Shelves, Desks, Nightstands & Wardrobes

Dura-Ply™ construction. "Open-shelf" design for enhanced safety and security. Solid 3/4" back panel for enhanced structural integrity. Catalyzed vinyl sealer coat plus catalyzed varnish top coat for wear resistance.



Single Wardrobe



3 Shelf Chest

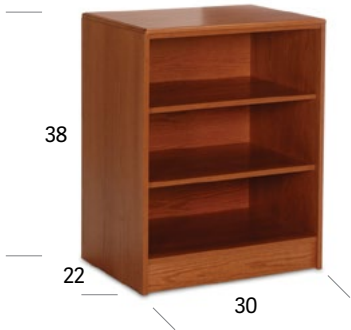

Nightstand



Colors



Oak



Cherry

Options

- Bed Headboard
- Bed Bottom Closure Panel
- Bed Restraint Rings

Desk

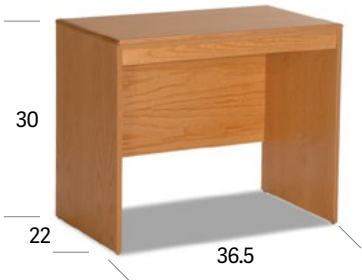

Titan® Series

Looking for residential furniture that can endure years of use in your facility's demanding environment? Look no further than the Titan® Series from Norix – a complete line of steel case goods that combines functional versatility with the institutional durability of all-steel construction. There's no substitute for the strength, safety and durability of steel furniture, and Titan® has emerged as the product of choice in institutional settings. Why? Because Titan was designed to perform in the most challenging healthcare environments. Titan® products are heavy and heavy duty. You don't have to worry that they'll be invaded by bedbugs, picked apart, or broken through intensive-use. Steel stands the test of time, and provides the best value option. Day in and day out – year after year – Titan performance.



Panel Base Bed

Available in Panel Base Bed, Bunkable Panel Base Bed and Panel Base Bunk. Steel deck, steel end frames for optional bunking. Ships K.D. Optional headboard, footboard, bunk-locking clamps, bottom closure panel, ladder and safety rails.

Remedy Sealed Seam Mattresses



Nightstand

Steel Nightstand with two non-removable drawers. Drawers feature padlock hasp locking mechanism. Institutional-grade laminated top. Optional matching laminated drawer fronts.





Wardrobe

Freestanding Wardrobe with one fixed shelf and safety J-bar for hanging clothes. Integrated recessed finger pull. Adjustable floor leveler glides. Available in Single Wardrobe and Double Wardrobe. Ships K.D. in two boxes.

Pedestal Desk

Steel Desk with healthcare-grade laminated top. Includes pencil drawer. Adjustable floor leveler glides.



Chest

Steel Chest with institutional-grade laminated top. Non-removable drawers. Available in 2, 3 and 5 drawer chests. Drawers feature padlock hasp locking mechanism. Optional matching laminated drawer fronts.

Steel Color

Optional Steel Colors*



Laminate

Optional Laminates*

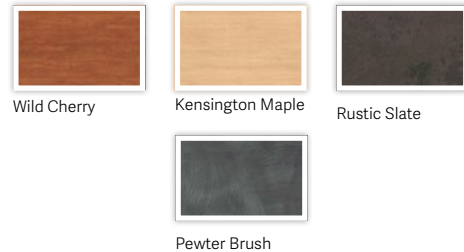

* Minimums required for color

Testing: GREENGUARD Gold Certified, Platform Bed 1,000 lb Static Load

Remedy Sealed Seam Mattress

Ideally suited for Behavioral Healthcare environments. Foam core for cushioned comfort with no inner springs. Separate or integrated pillow options. Available in standard healthcare sizes. Polyurethane coated cover with welded seams for enhanced hygiene, security and durability. Remedy Series Mattresses feature 100% sealed seams that are radio frequency welded and guaranteed not to break.

REMEDY NORIX BLUE



Norix Blue

Norix Blue is a durable mattress with infection control features that make it suitable for daily use in critical environments. It features 100% sealed seams for unsurpassed seam strength and a durable polyurethane coated cover. Day in, day out, Norix Blue will perform well above your expectations.

Shown with Titan® Panel Base Bed



REMEDY SILVER SECURE



Silver Secure

Silver Secure is the perfect mattress for those facilities needing more durability and infection control than what is found in your typical healthcare mattress. It's constructed with a durable polyurethane-coated cover with reinforcing ripstop scrim, along with enhanced break strength for added security. An applicable product for the intensive-use found in healthcare environments.

Shown with Attenda® Sleigh Bed

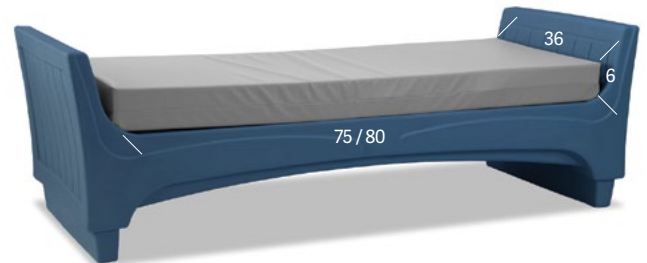
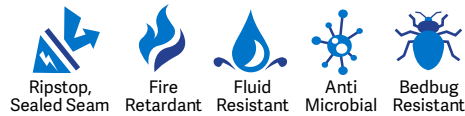

REMEDY BLACK MAX



Black Max

Black Max is our most durable mattress and is suitable for the most extreme-use spaces in your facility. That's because the mattress is constructed with 100% sealed seams that are reinforced with maximum security stitching for unsurpassed seam strength. It's also constructed with an extremely impervious, polyurethane coated cover with reinforcing ripstop scrim. All of this makes Black Max highly durable and resistant to constant-use, bodily fluids, bed bugs and other challenges you may find in healthcare settings.

Shown with Attenda® Floor Mount Bed

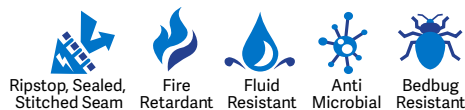

Testing: GREENGUARD Gold Certified, 16 CFR Part 1633, 16 CFR Part 1632, California Technical Bulletin 129, ASTM F1566, ASTM D751

Attenda® Bed & Restraint System



Our Attenda® Beds are made of rotationally-molded, specially formulated, high-impact polyethylene. For extra security, Norix offers an optional restraint bed conversion kit that consists of six heavy-duty restraint rings that mount through the bed and bolt to the floor.



**Ask about our innovative
NEW REMOVABLE RESTRAINT RING!**

4.4

Safehouse® Bed & Restraint System

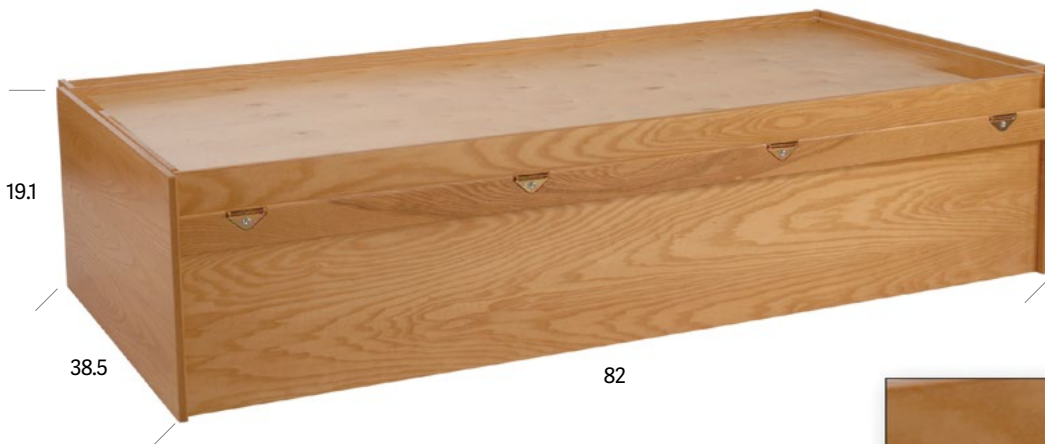

Our Safehouse Beds have the therapeutic qualities that come with real wood products. These beds are made of 3/4" plywood with natural hardwood veneer and impact resistant PVC edge banding. For extra safety, Safehouse Beds can be equipped with a restraint bed conversion kit that consists of eight heavy duty D-rings that mount through a 3/4" solid hardwood veneer panel.

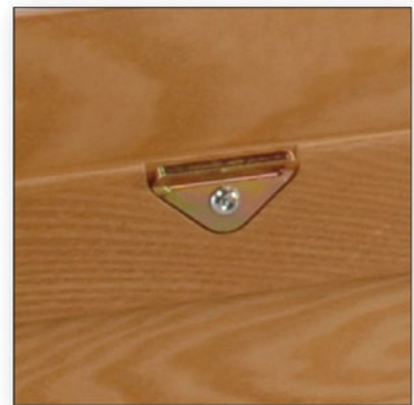

Hondo Nuevo® High Back Chair

Comfortable lumbar support and ergonomically correct style for comfort and easy egress.

3 lb density polyurethane foam filling for cushioned comfort.

Seamless chemically resistant surface is easy to clean and sanitize for greater infection control.

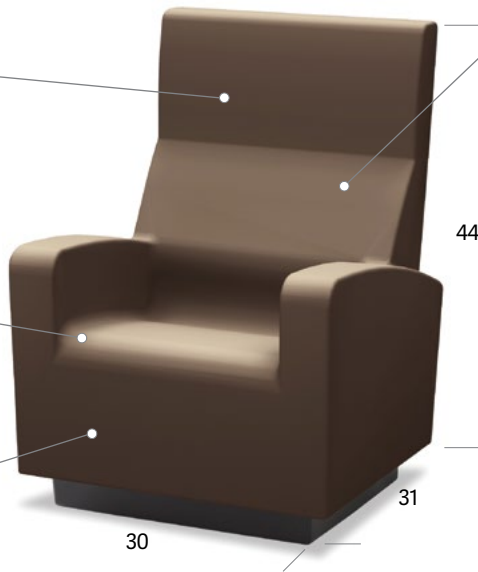

Extremely durable, 1/4" thick rotationally-molded skin is impervious to fluids.

Seat Color



Molded Wood Grain Legs



Molded Plinth Base



Steel Base Color



Options: Ganging Kit, Floor Anchoring

Testing: GREENGUARD Gold Certified, California Technical Bulletin 133, UL1056, ASTM E1537, NFPA 261, UL94 HB, British Standard BS 7176: 2007, BIFMA 5.4 15.4.2 750 lb Static Load

Harmony™ High Back Chair

Generous seat width and cushioned support provide comfortable lounging.

Highly durable polyurethane arm caps are one piece, full length, pick resistant and securely bolted to steel frame.

Comfortable lumbar support and ergonomically correct style for comfort and easy egress.

Upholstery

Our upholstery comes in a variety of performance grades so you can choose the appropriate vinyl for your facility. Both seat and back cushions are field replaceable.



Robust fully welded steel frame for maximum strength and durability.

Injection-molded nylon feet are engineered for strength and to protect floors.

Polyurethane Arm Caps and Molded Nylon Feet



Options: Full or Short Apron, Clean Out or Standard Fit, Open or Closed Bottom, CAL TB 133 Upgradeable Upholstery

Testing: GREENGUARD Gold Certified, California Technical Bulletin 117, BIFMA 5.4 15.4.2, 1000 lb Static Load



Attenda® Sleigh Bed

The Attenda® Sleigh Bed introduces contemporary design for a more residential, normalized appearance without sacrificing advanced construction for intensive-use applications in healthcare environments. Ideal for geriatric patients, the higher sleep surface makes it easier to administer to patients while the raised bed deck easily accommodates a patient lift device. Available with or without drainage holes.



Ideal for incontinent patients. Optional drain holes allow fluids to drain away.



Attenda® Platform Bed Riser

Free-standing or floor mounted bed riser designed to pair with the Attenda Floor Mount Bed for staff friendly bed height, easy patient egress and convenient use of a patient lift device. Optional riser raises 15" sleep surface an additional 8" and features a knock out access port and push cap for ballasting in free-standing applications. Bed fastens securely to riser at the existing anchor locations of the bed (tamper-resistant connecting hardware included). Pairs with ATN100 or ATN101 beds (retrofit capable). Available in Moss or Fossil colors.

Bed Colors



Lagoon

Pine Cone

River Rock

Graphite

RockSmart™

RockSmart is a contemporary rocking chair designed from the ground up for soothing comfort, exceptional durability and aesthetic appeal. Its signature one-piece shape is sculpted from rotationally-molded polyethylene for a calming, safe and comfortable rock. The 18" is slightly taller, wider, and deeper. Both have a heavier formulation should your facility need a more secure ballasted rocker. Available in two sizes and weights to fit your needs.

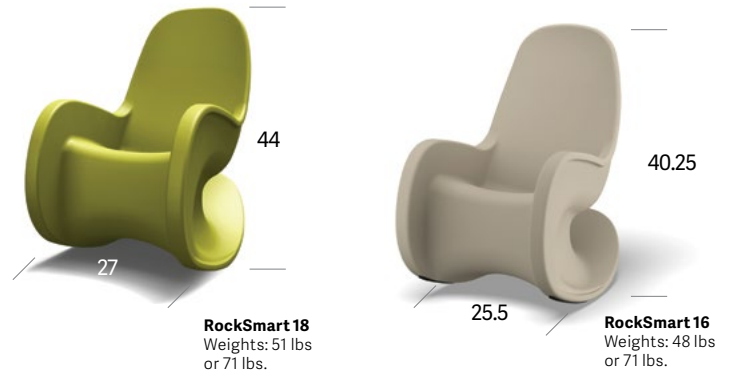

TruColor™ Premium material is fully compounded for superior color and quality assurance.

No assembly required.

Engineered to Endure. Dynamic drop tested to a relative impact force of two times BIFMA 5.4 15.4.2 and 500 lb static load while also CAL TB133 compliant.

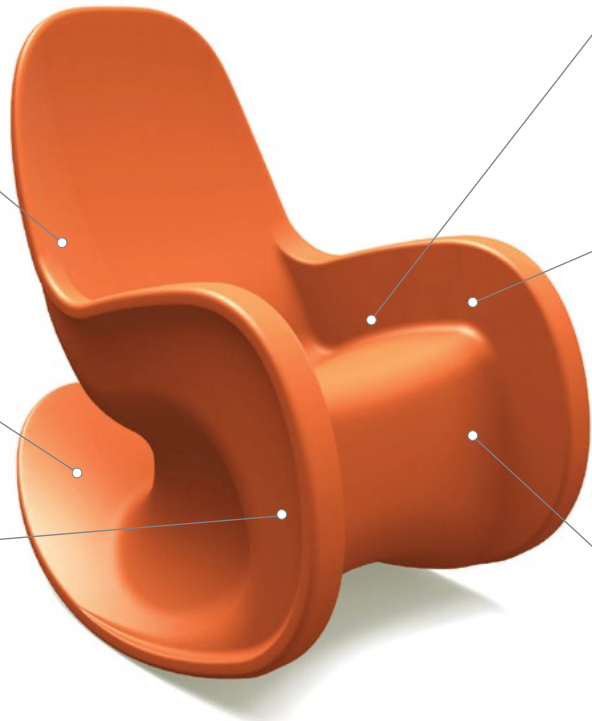

Sculpted shape provides an ergonomically comfortable sit.

The original rocking chair for Behavioral Healthcare facilities.

One-piece rotationally-molded polyethylene with lightly textured surface allows for easy cleaning.

Seat Color



Testing: GREENGUARD Gold Certified, California Technical Bulletin 133 UL1056, ASTM E1537, NFPA 261, UL94 HB, British Standard BS 7176: 2007, 500 lb Static Load

Vesta Seating

One curvy design with tons of upholstery options

The Vesta chair collection provides a unique blend of ultra-safe design with beautiful curved surfaces and colors. The sweeping form fully contacts the floor to mitigate ligature points and can be ballasted for extra security. The rotationally-molded polyethylene is easy to sanitize and provides superior durability.

Anti-Ligature Design Full Contact from Base to Floor

Vesta's attractive residential appearance is an effective resource for creating a comforting therapeutic environment. Cushioning is attached with hidden staples and secure hardware to assist in keeping products safe and tamper-resistant.

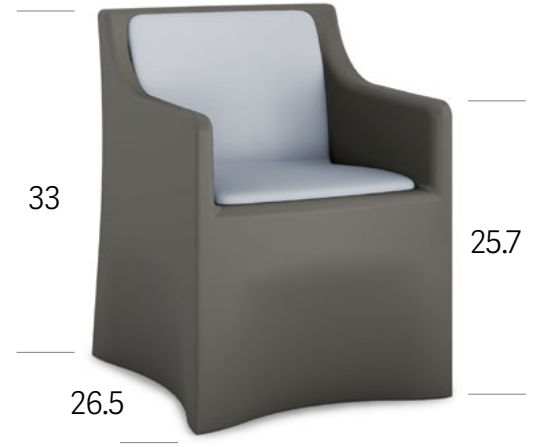

Seat Color



Options: CAL TB 133 Upgradeable Upholstery

Testing: GREENGUARD and GREENGUARD Gold Certified, UL 2818. UL.COM/GG, BIFMA 5.4 15.4.2, ANSI/BIFMA X5.4-2012, 750 static load

Integra Armless

Integra chairs are specifically designed for intensive use applications, yet comfortable and lightweight. They're molded in one piece so you don't have to worry about assembled components coming loose. They're stackable and they pass the rigid California Technical Bulletin 133 Flammability Test.

Each chair weighs only 7 lbs so stacking 15 of them in a seven foot high space is easily accomplished.



Molded from high-impact grade copolymer polypropylene. Passes the rigid California Technical Bulletin #133 Flammability Test.



Seat Colors





Multi-Purpose Series

Most commercial tables are put together with easily removed screws, nuts, bolts, screw-out glides and snap-on parts. Norix created the Multi-Purpose Series of tables specifically to avoid those attributes so you don't have to think about the possibility of injury by altered furniture parts.

45 lb density M3 grade particle board with embedded T-nuts sandwiched with decorative laminate and backer sheet.

Product tested to 500 lb static load.

Edge is routed to receive glued and pinned black vinyl T-molding. 1/4" thick edge profile.



Heavy-duty construction with commercial grade laminate surface and glued and pinned T-mold edge. Legs fastened to embedded T-nuts.

12 gauge steel tubes, fully welded and sealed on exposed ends. Glides adjust for leveling, but are tamper-resistant as a security precaution.



Laminates



Kensington Maple



Montana Walnut



Asian Sun

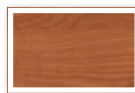

Wild Cherry

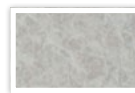

Titanium Evolve

Leg Color



Black



Metallic Silver



Testing: GREENGUARD Gold Certified, 500 lb Static Load



SafeDoor | Anti-ligature

SafeDoor from Norix Furniture provides a balance of safety and privacy in demanding environments. This unique door design hangs with magnetic nylon hinges that attach to metal door frames but collapse with just 20 pounds of force mitigating ligature risk. The high-quality vinyl material is RF welded over high-density polyurethane foam to withstand abuse. SafeDoor is chemically resistant to body fluids and easy to clean. Made in the U.S.A.

Details

- Highly durable vinyl with no ligature points
- Sealed seam construction
- Compliant with flammability standards ASTM E84 and California TB133
- Compliant with Material standards California Title 19, Sec. 1237.1 Small Scale test and NFPA 701-2015, Method 1
- Nylon hinge is available on the left or right side.
(Must be specified at time of order)

Print Options



River Stone

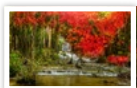

Autumn Waterfall



Cascading Waterfall

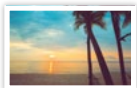

Tropical beach



Spring Blossom

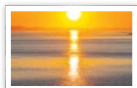

Golden Sunset



Pine

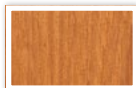

Teak



Washroom Accessories

Safety is the issue and Norix has the solution. All accessories are easy-to-clean stainless steel.

ADA Shower Seat

Stainless steel detention-grade recessed shower seat. ADA version meets ADA 4.21.3 & 4.26.3 requirements for L-Shaped Shower Seats.

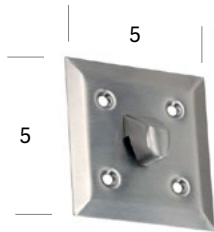
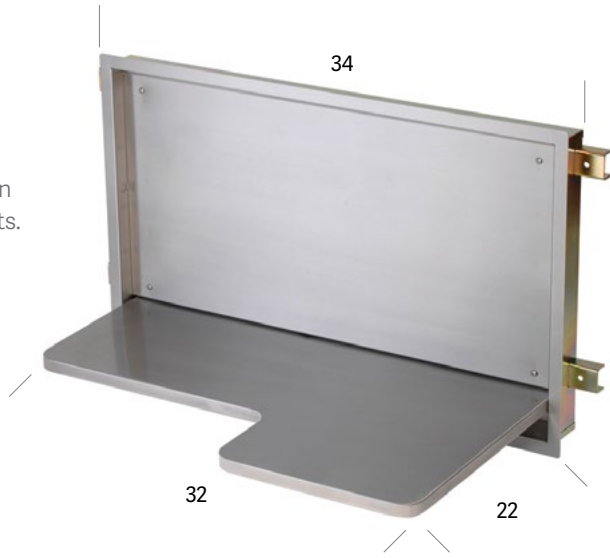

Towel Hooks

Holds towels or clothing articles safely without the use of protruding pegs or hooks. The surface mounted towel hooks come in stainless steel. Choose from single towel hooks or groups of four.

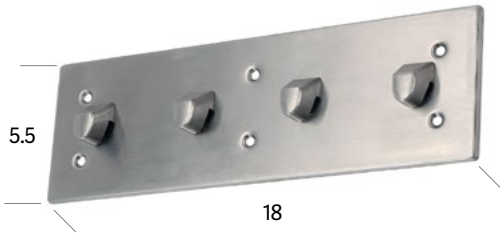

Wall Mirror

One-piece #430 stainless steel. Highly polished #8 finish. Two standard sizes: 9 1/2" x 11 1/4" and 11 1/4" x 17 1/4". Mount direct to wall or with an optional 1/4" thick steel backer plate. Optional embed plate also available.



Recessed Shelf

No sharp corners or edges protruding from the wall to inflict injury. The chase-mounted recessed shelf comes in easy-to-clean stainless steel.

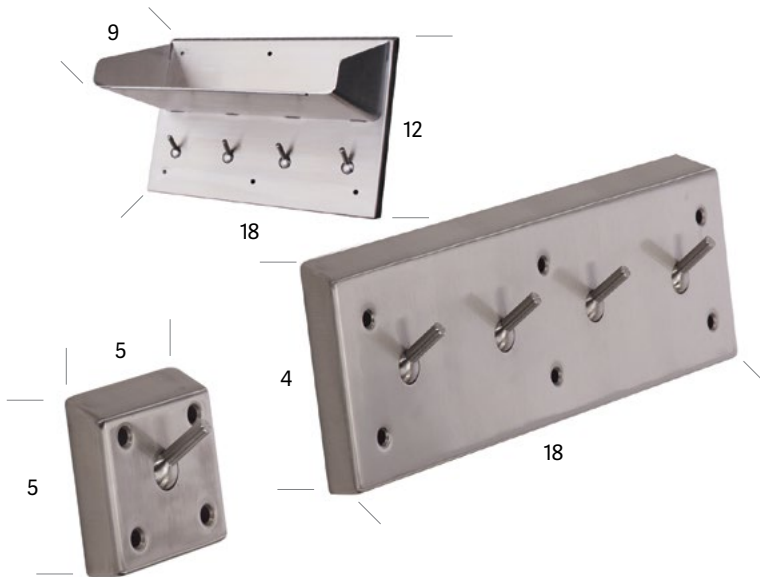
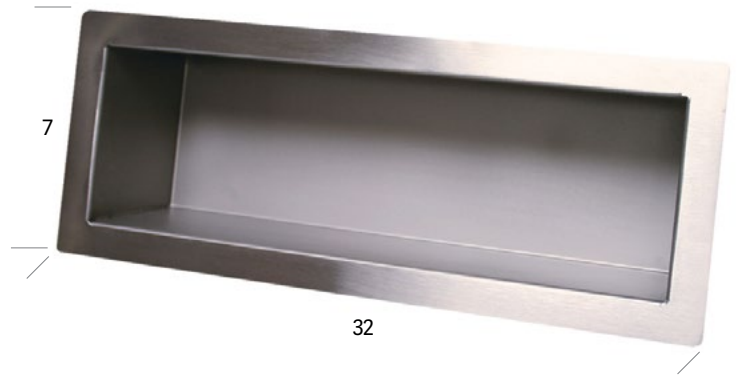

Ball Clothes Hooks

Single collapsible safety hooks or groups of four with optional 8" deep X 18" long bookshelf. Ball and stem style in stainless only.

Toilet Paper Holder

Front mount, in easy-to-clean stainless steel.

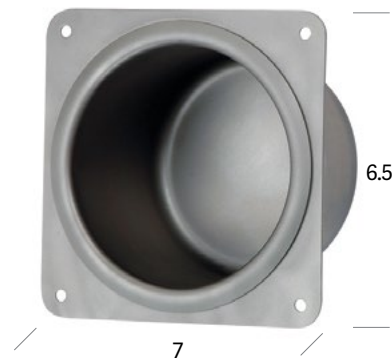

Color



Stainless Steel

Testing: GREENGUARD Gold Certified



19 / 27



DuraVision™ Mirrors

DuraVision™ polycarbonate mirrors from Norix are designed specifically for the challenging conditions found in healthcare facilities. The strength of polycarbonate combined with a solid, full foam backing and a unique steel frame design ensures these mirrors exceed the breakability and tamper resistance of any other product on the market.

Behind the Reflection

Most convex mirrors you see in commercial establishments and at intersections are made from acrylic. When tested to withstand impact, they'll be the first to break into knife-like shards. Our polycarbonate mirrors, with pure reflective coatings, are premium 3mm grade with a tensile strength of 9,400 psi. To further enhance the strength, we completely fill the cavity behind the mirror with high-density water blown urethane foam to limit the compression distance, thus eliminating the possibility of breakage from a severe blow. To make sure they stay in place, the DuraVision™ mirror perimeter is fully enclosed in a heavy duty powder coated steel frame that sits flush with the wall and ceiling and features countersunk screw holes to receive tamper-resistant fasteners.

20 / 25.5 / 38



11 / 13 / 9

20 / 26



6.5 / 8.5

Eliminating Blind Spots

DuraVision mirrors were designed to ensure the safety of facility, staff and patients. DuraVision™ mirrors permit staff the opportunity to observe blind corners and intersections without putting themselves or others in harm's way.

Testing: GREENGUARD Gold Certified



16.25

16



20

ADA Oasis™ Cafeteria Table

Sturdy, healthcare grade tables with fixed seating. Laminate top with molded radiused edge.



Prodigy™ Desk

Classic table desk with modesty panel. Attractive inset panel design allows for placement flush against wall or in corners. ADA compliant.

Attenda® Desk

Laminate top with molded radiused edge. Mounts securely to floor. ADA compliant.

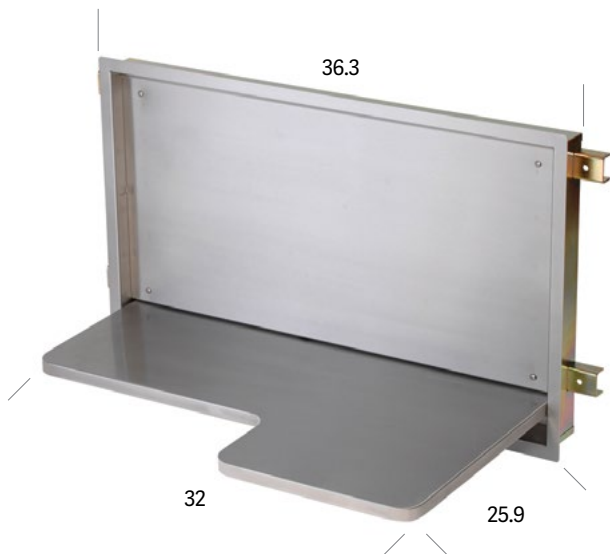

ADA Shower Seat

Healthcare grade, recessed ADA compliant shower seat. Easy-to-clean stainless steel finish.



Norix Installation Services

Norix education furniture is safe, secure and built to last ...providing outstanding long-term value and peace of mind for your staff. For facilities not using contractors or consultants, it makes sense to reinforce the benefits of the furniture with a installation from Norix.

Benefits of Installation Services:

- Expert installation services, performed by professionals experienced in all facility installations.
- Complex installation capabilities, including field drilling into concrete, secure bolt-down and application of security caulk.
- All labor, installation hardware and materials included.
- Seamless transaction on same purchase order as furniture.
- Reinforces product warranty.





**AT NORIX, WE DESIGN INNOVATIVE,
ROBUST FURNITURE THAT MEETS THE
REAL-WORLD NEED FOR HUMANIZING
CHALLENGING ENVIRONMENTS.**

Norix is not just a corporation, we're a family. We care about the people we serve, our community and our team.

We create contemporary designs that humanize our industry without sacrificing robust structural integrity.

Our products are built with the wellbeing of the people who use the furniture in mind, as well as the people around them.

[NORIX.COM](https://www.norix.com)

AT NORIX, WE DESIGN INNOVATIVE, ROBUST FURNITURE THAT MEETS THE REAL-WORLD NEED FOR HUMANIZING CHALLENGING ENVIRONMENTS.

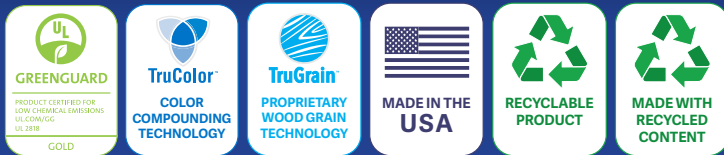

Individual attributes vary by product. See specification sheet for details



NORIX[®]
BEHAVIORAL HEALTHCARE

One Innovation Drive, West Chicago, Illinois 60185
Phone: 630-231-1331 | Toll Free: 800-234-4900 | Fax: 630-231-4343
4/21 | furniture@norix.com ©2021 Norix Group, Inc.

NORIX.COM